



EPA 100



PROCESS CONTROL DEVICE

USER

MANUAL

1. INDEX

1.	INDEX.....	2
2.	TECHNICAL SPECIFICATIONS.....	4
2.1	ELECTRICAL SPECIFICATIONS.....	4
2.2	MECHANICAL DIMENSIONS.....	5
3.	CONNECTIONS.....	7
4.	FRONT PANEL DEFINITIONS.....	8
5.	MENU TREE.....	9
6.	SETUP.....	10
6.1	CONNECTING THE SENSOR TO THE DEVICE	11
6.1.1	Connections of the potentiometer:.....	11
6.1.2	Connections of 4-20mA, 0-20 mA or 0.5-4.5 V, 0-5 V, 0-10 V sensors:.....	11
6.1.3	Connections of mV / V Ratiometric Sensor:.....	12
6.2	CALIBRATING DEVICE	13
6.2.1	Determining Scale Value	13
6.2.2	Determining Factor.....	13
6.2.3	Calibration Method Determination.....	14
6.2.4	Automatic Calibration	15
6.2.5	Error Message.....	15
6.3	ENTER RELAY SET VALUE	16
6.3.1	Relay 1 Output Settings (OUT-1)	16
6.3.2	Changing Quick Set Values	16
6.4	TRANSITION TO PROGRAMMING MODE	17
6.4.1	Selection of Relay Function	17
6.4.2	Delay.....	19
6.4.3	Histerezis	19
6.4.4	Offset Value.....	19
6.4.5	The Default State of The Relay	19
6.4.6	Sensor Selection (Snsor).....	19
6.5	ANALOG OUTPUT SETTINGS.....	20
6.5.1	Analog Output Type Selection.....	20
6.5.2	Analogue Output On Off.....	20
6.5.3	Inverse	20

6.5.4	Analog Output Scale Setting.....	20
6.6	DIGITAL OUTPUT SETTINGS (COMMUNICATION)	20
6.6.1	UART Settings	20
6.6.2	CANopen Settings.....	21
6.7	SECURE MENU	21
6.7.1	Hide Menu (HIDE).....	21
6.7.2	Menu Lock (LOCK)	21
6.7.3	Password Determination (PASS).....	21
6.7.4	Return to Factory Settings (FTRY).....	21
6.7.5	Restart the Device (RESET)	22
7.	OTHER SETTINGS	23
7.1	DISPLAY MENU [DISP].....	23
7.1.1	Decimal Point (POINT).....	23
7.1.2	The Tare Function (TARE)	23
7.1.3	Viewing the Max and Min Values That Are Read (PEAK)	24
7.1.4	Screen Refresh Rate (REFRS)	24
7.1.5	Preventing Unstability on the Screen (FILTR).....	24
7.1.6	Second Line Identification on the Screen (LINE)	25
7.1.7	Keypad Setting (SOUND)	25
8.	OPERATION MODULE FUNCTIONS	26
8.1	TARE FUNCTION	26
8.2	VIEWING THE MAXIMUM AND MINIMUM READ VALUES	26
9.	PRODUCT CODING.....	27
10.	WARRANTY DOCUMENT	28

2. TECHNICAL SPECIFICATIONS

2.1 ELECTRICAL SPECIFICATIONS

Supply Voltage	24 V _{AC/DC} 50/60 Hz 85-265 V _{AC} 50/60 Hz	
Power Usage	9 VA / 2,7 Watt Maximum	
Sensor Supply Voltage	Pot:	10 V _{DC}
	mV/V:	10 V _{DC}
	0-10V:	24 V _{DC}
	0-5V:	5 V _{DC}
	0,5-4,5V:	5 V _{DC}
	4-20 mA:	24 V _{DC}
	CANopen:	24 V _{DC}
Max Sensor Supply Current	100 mA	
Refresh Rate	3.5 kHz	
Resolution	16 bit	
Analogue Inputs	Potentiometer, 0.5-4.5 V, 0-5 V, 0-10 V, 4-20 mA, 0-20 mA, 3.33 mV/V, 2mV/V, 2.5mV/V Ratiometric	
Relay Outputs	2 Piece 250 V _{AC} 3A (For Resistive Load) Relay	
Serial Communication (Optional)	RS-232, RS-485, USB, CANopen	
Analog Outputs (Optional)	0-10 V, 0-5 V, 0.5- 4.5 V, 4-20 mA, 0-20 mA	
Analog Output Resolution	12 bit	
Connection	2,5 mm ² Socketed Terminals	

2.2 MECHANICAL DIMENSIONS

Dimensions	48 x 48 x 96 mm
Weight	200 gr.
Assembly	It is fixed to the panel with the feet at the top and bottom.
Operating temperature	0 to 50 °C
Storage temperature	-10 °C to 60 °C
Protection Class	IP60 Front Panel, IP20 Back Panel

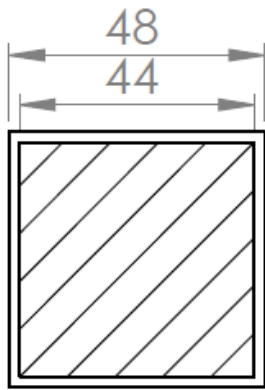

SECTION A-A

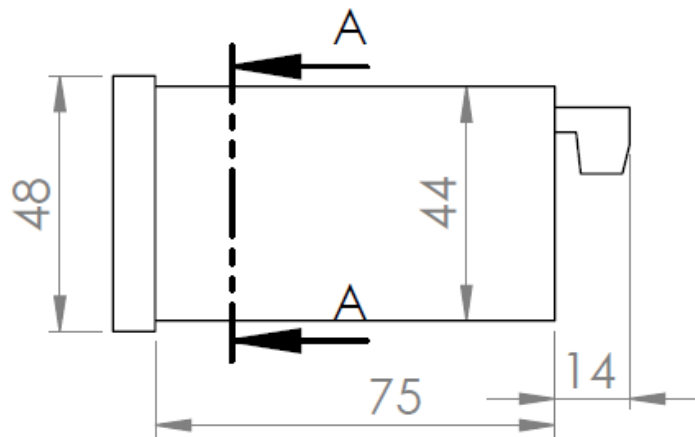



SAFETY WARNINGS



1. Follow the instructions and warnings in the user guide.
2. Please check the power supply type before connects energy to the device.
3. Please the device mounted on panel against dangers of fall, snap, shake during working.
4. Make Sensor connections without energy on the device; do not connect in any way during operation.
5. Make sure that is shielded cables between device and sensor.
6. Do not leave the device exposed to a heat source (solar, heater etc.)
7. EPA100 industrial control device is not suitable for use in the external environment, Use only room conditions.
8. Wipe with a damp cloth to clean the device, do not use water, thinner etc.
9. Comply with the limit values specified in the technical specifications for relay outputs.
10. The device cannot be changed by the user in the event of a fault, Please contact our technical service in case of failure.

3. CONNECTIONS

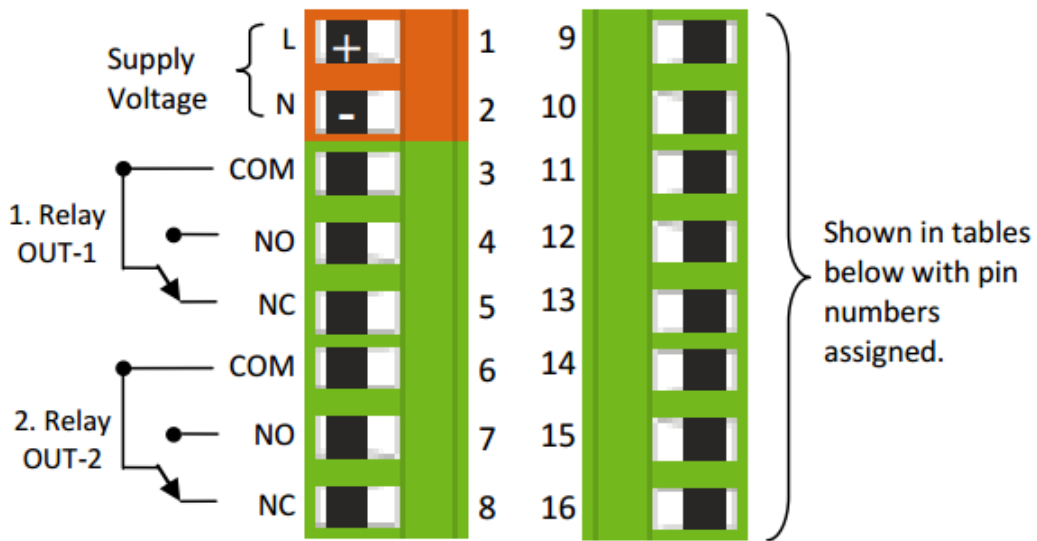





Digital Connections	9	10	11
RS485	A	B	GND
RS232	Rx	Tx	GND
USB HID	USB CONNEKTOR (B Type FEMALE)		
USB VIRTUAL	USB CONNEKTOR (B Type FEMALE)		
CANopen	CAN HIGH	CAN LOW	GND

Analog Outputs	12	13
4-20 mA 0-20 mA 0-10 V 0-5 V 0.5-4.5 V	Signal Output	GND
Tare Input	Tare Input	GND

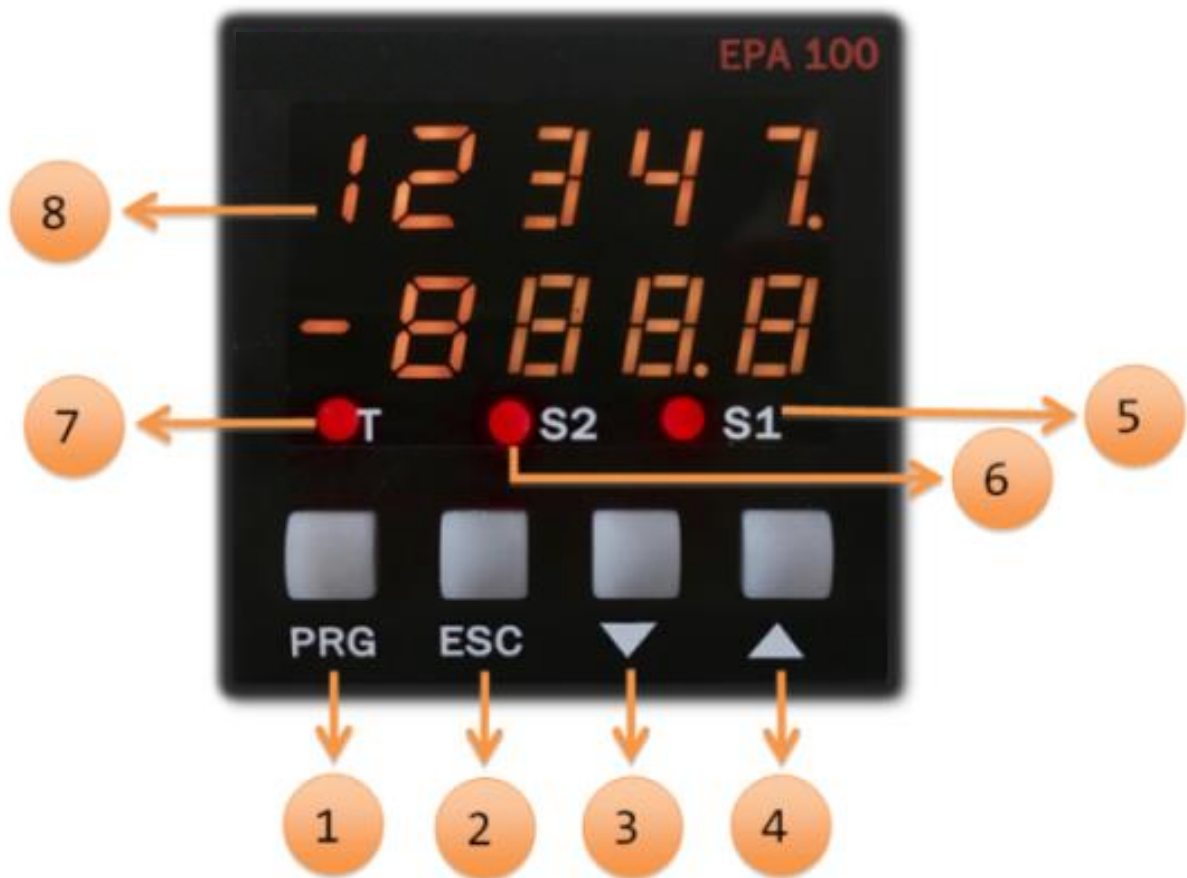
SENSOR	12	13	14	15	16
Potentiometer	X	X	1 No Terminal	2 No Terminal	3 No Terminal
4-20 mA Input 0-20 mA Input 0-10 V Input 0-5 V Input 0.5-4.5 V Input	X	X	Sensor Supply	Signal Input	GND
mV/V Input	Signal(+)	Signal(-)	Sensor Supply	X	GND

4. FRONT PANEL DEFINITIONS



- 1) PRG (): Programming button. It is used to enter the menus or confirm the entered values.
- 2) ESC (): Escape, exit and backspace key. Used to go back or exit a parent menu.
- 3) DOWN (): Down key. Navigating between menus; Used to decrease the value when entering a value or to switch to a lower digit. It also allows you to see the readings (minimum and maximum) on the display while the device is in operating mode.
- 4) UP (): Up key. Navigating between menus; Is used to increment the value or move to a higher digit when entering a value. It also activates the Tare function while in run mode. Please refer to "Setting" 7.1.2.
- 5) **S1** Status LED: 1. Display when the relay output is active.
- 6) **S2** Status LED: 2. Indicator light when relay output is active.
- 7) **T** Status Led: Indicator that is lit when the key function is active.
- 8) Display Screen: Display screen consisting of 5 lines in 2 lines.

5. MENU TREE

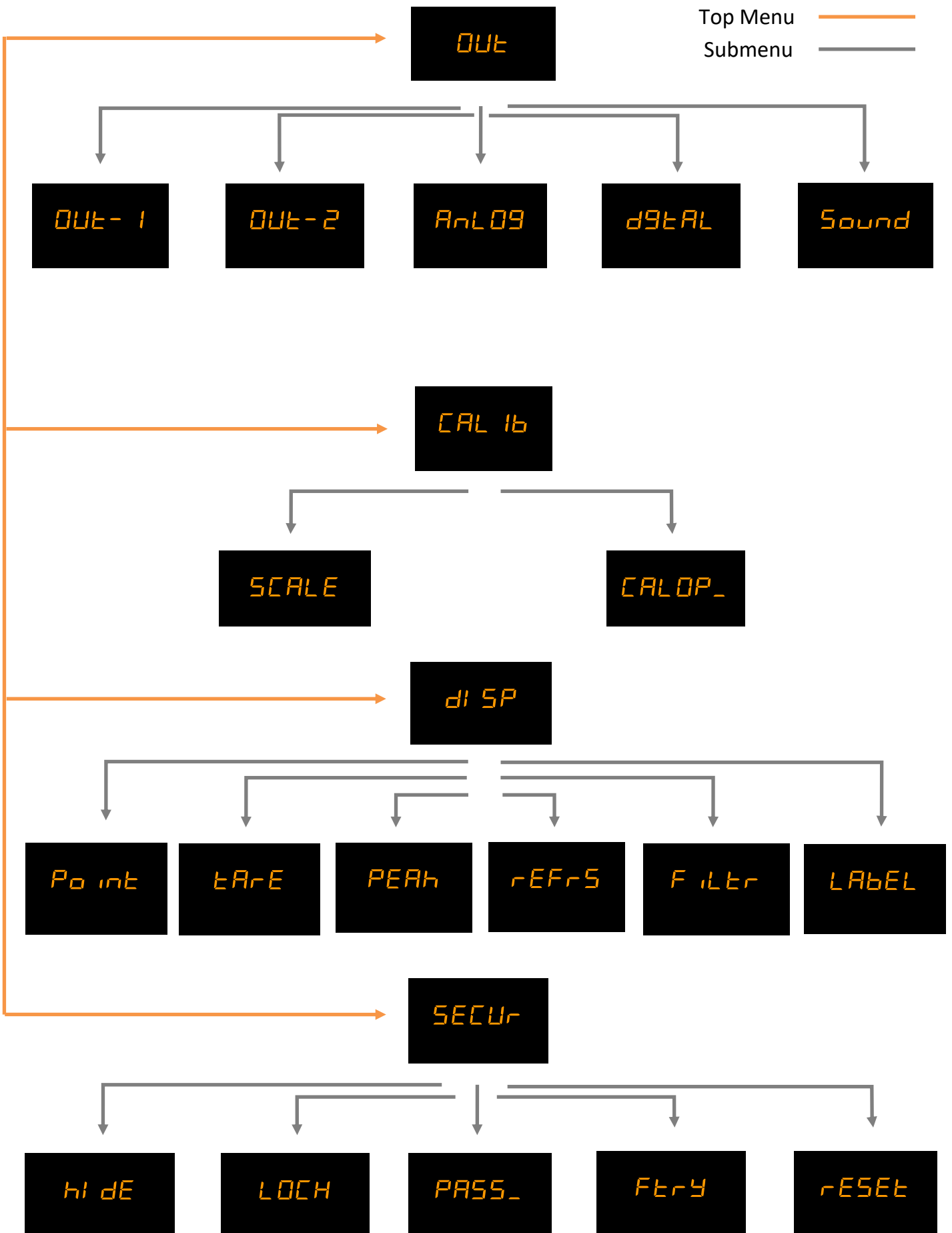

6. SETUP

The recommended installation steps are as follows.

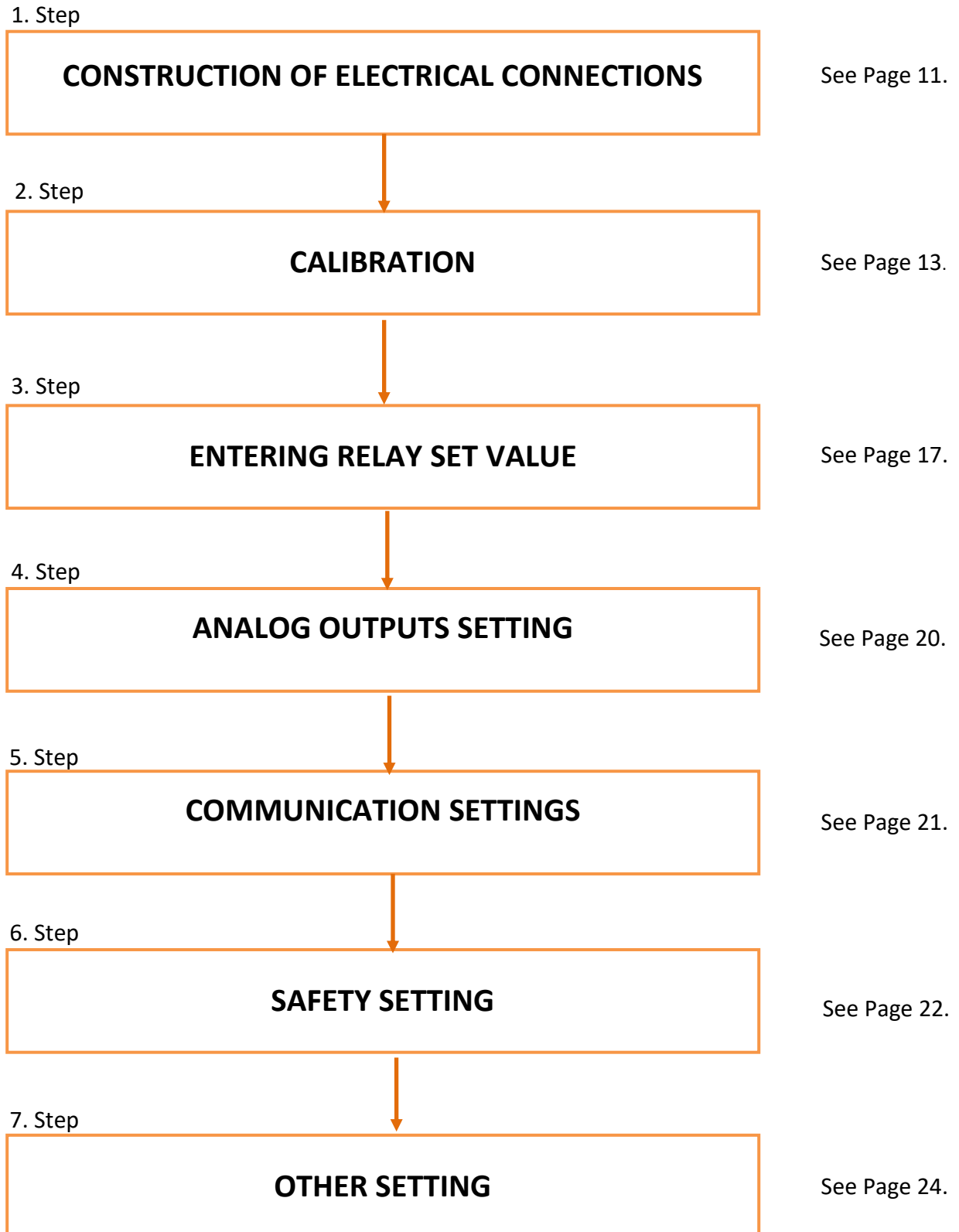

6.1 CONNECTING THE SENSOR TO THE DEVICE

6.1.1 Connections of the potentiometer:

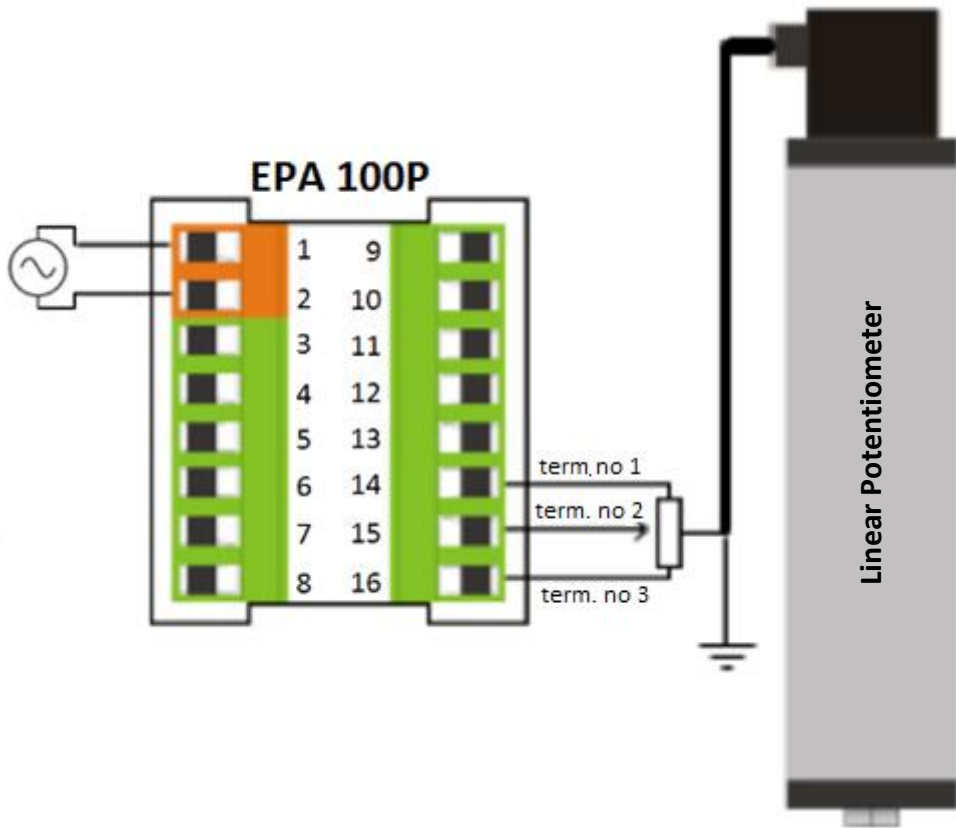

6.1.2 Connections of 4-20mA, 0-20 mA or 0.5-4.5 V, 0-5 V, 0-10 V sensors:

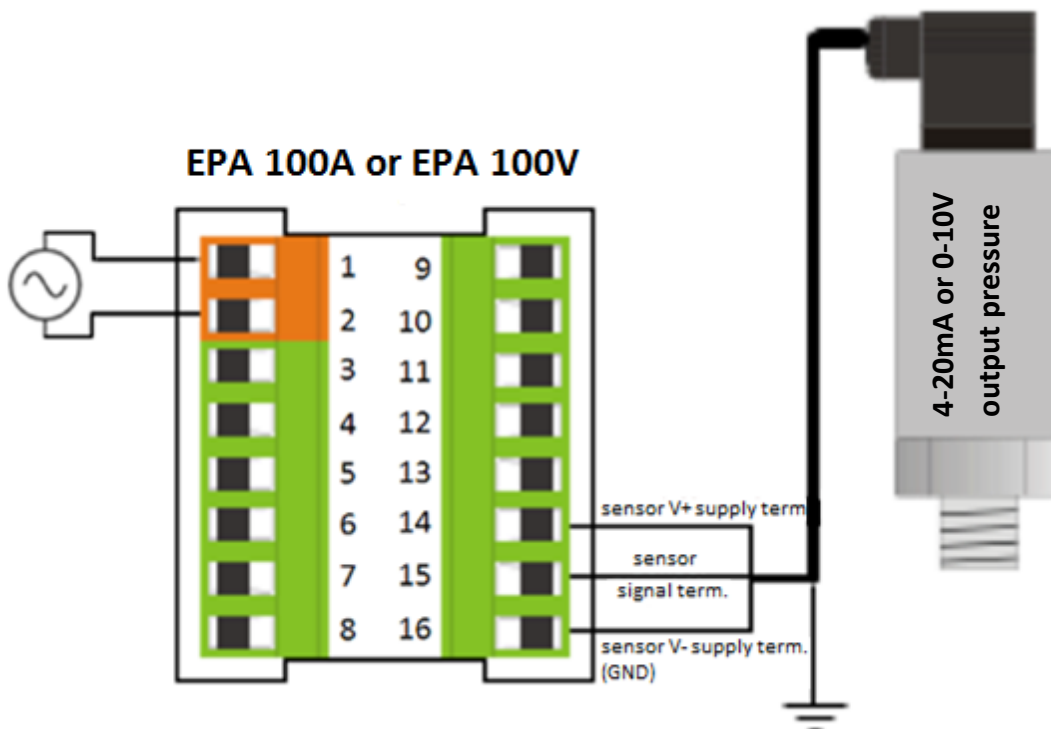

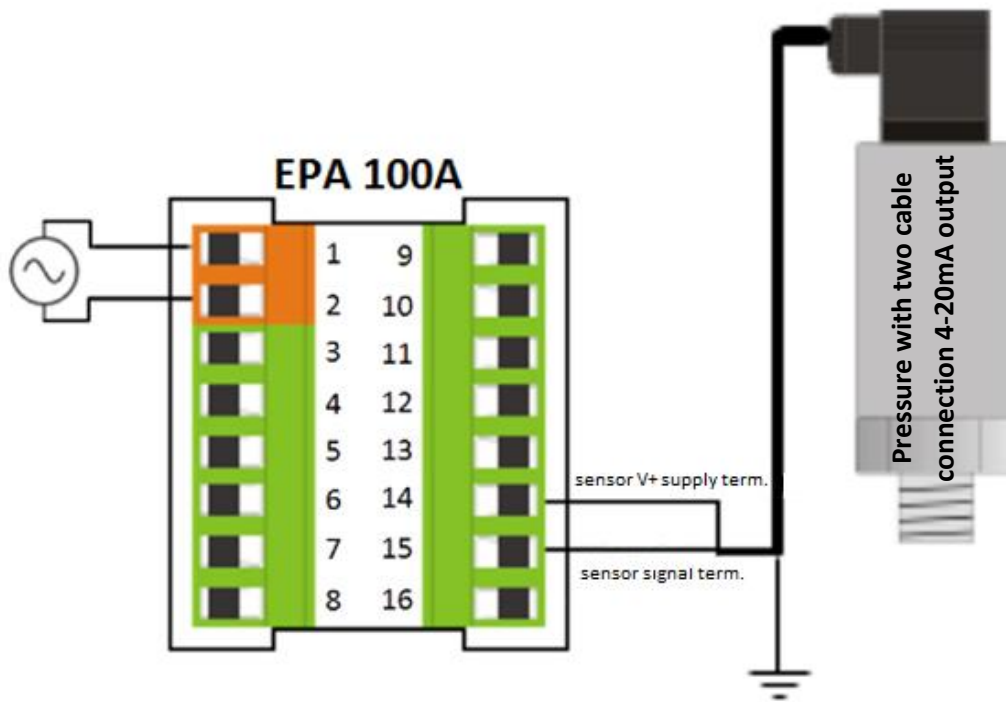

6.1.3 Connections of mV / V Ratiometric Sensor:

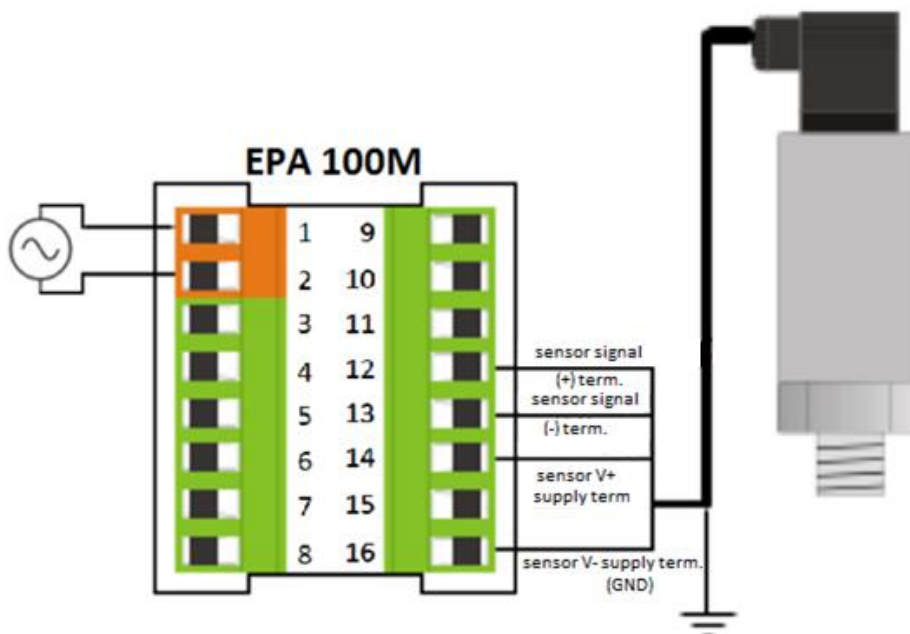

Press and hold the PRG key to switch to the programming menu.

6.2.1 Determining Scale Value

When your device is calibrated to its factory settings, it operates at a value range of 0-100. That is, the smallest reading on the sensor shows 0 on the screen and 100 on the screen. You can change the scale from this menu.

Use the S-LO for the minimum value of the scale, and the S-HI menus for the maximum value. To change the value, press the PRG key. The display on the right will start blinking. You can change the value using the up and down keys. Then press the PRG key again to locate the decimal point. Then press the PRG key to confirm the value.

For a example application please see page 14.

6.2.2 Determining Factor

You can use the Fctor menu to expand this scale by multiplying it by a fixed factor. The number of this factor, which is the default value of 1, is multiplied by the values of S-LO and S-HI to determine the scale value.

For example; When you set the S-LO value to 1, the S-HI value to 20 and make the factor 4, your device will operate in the 4-80 value range.

WARNING: Changing the scale and factor value does not change the calibration of your device, it only indicates the displayed value range on the screen. For the calibration of the device, please see 6.2.3.

Example:

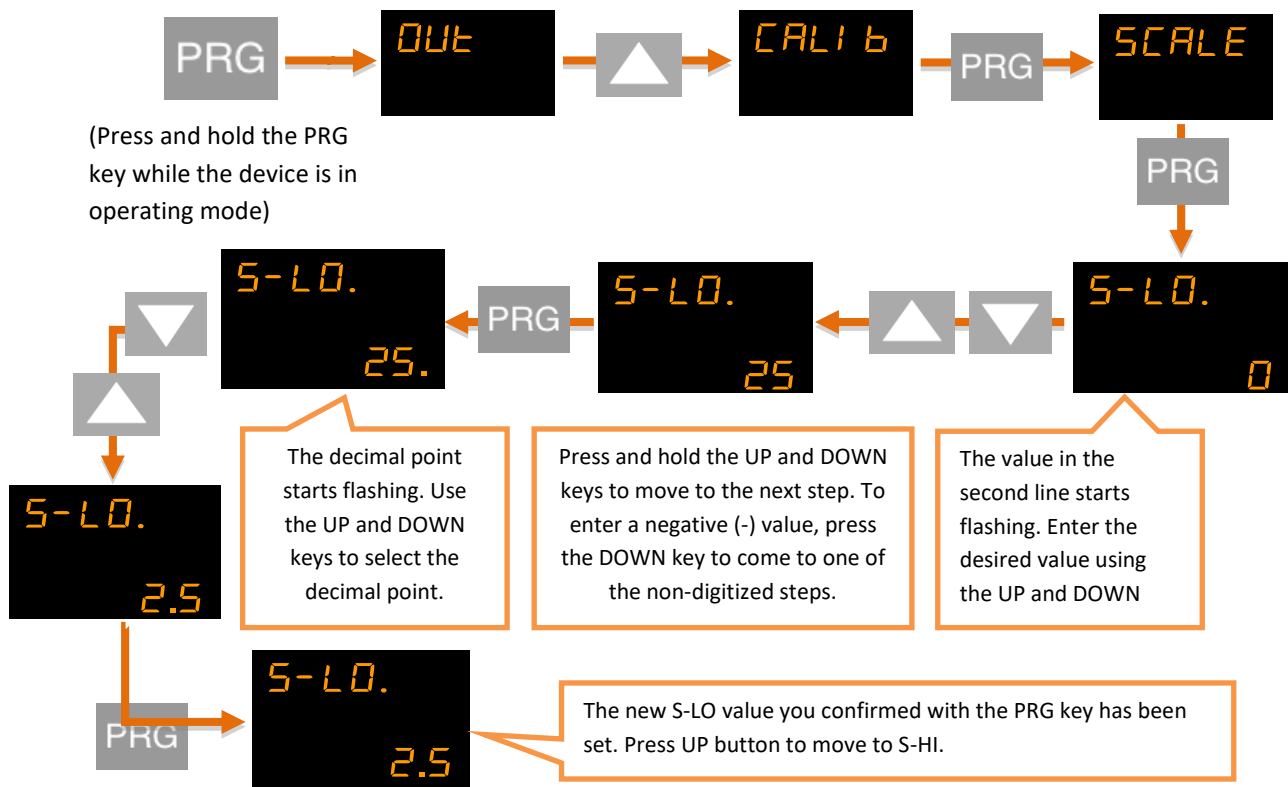

After specifying the S-LO value, you can do the same for the S-HI value.

6.2.3 Calibration Method Determination

CALOP.

Your device has been calibrated during production. If you want, you can do this calibration according to the sensor. You need to select the calibration method from this menu.

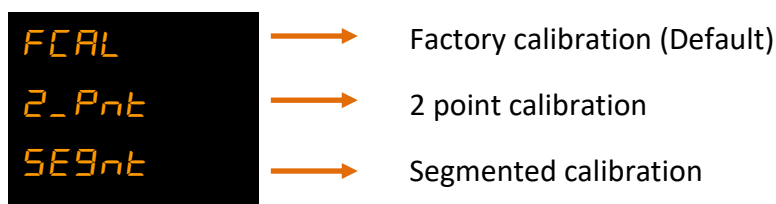

6.2.3.1 Factory calibration (default)

The default calibration on your device. The multipoint calibration or the two points you make your device does not disturb the factory calibration.

6.2.3.2 Two-point calibration

In the two-point calibration option, only the maximum and minimum points are selected. For example; When calibrating a 10 cm linear potentiometer, the potentiometer is set to the minimum point in the fully closed position, while the potentiometer is fully open.

6.2.3.3 Multi (segmented) calibration

With the multiple calibration option, you can calibrate your device at up to 10 different points. This method increases the linearity of the sensor.

For example; If the length of the sensor is 40 cm and you want to calibrate at 5 different points, these points are; There may be 0. cm, 10. cm, 20 cm, 30 cm, and 40 cm points where the sensor ends. These points can be set anywhere in the scale range. We recommend that you choose equal intervals for a more suitable linearity.

6.2.3.3.1 Number of Calibration (CL.CNT)

In this menu, which appears when you select the segmented calibration option, you can specify the number of points you want to calibrate the device. It's a maximum of 10.

6.2.4 Automatic Calibration

From this menu, you can start automatic calibration by pressing the PRG key according to the calibration method you selected in section 6.2.3.

- If you have set the calibration method to Two Point Calibration, press the PRG key and CAL-L will blink while the sensor is at the minimum point. Press the PRG key to set the CAL-L value. After this, the CAL-HI indicator will blink while you move your sensor to the maximum point. Press the PRG key to set the CAL-HI value.
- If you have set the calibration method to Multi Calibration. During calibration; You can see the calibration point you will set on the first line with the flashing segment number and on the second line the unprocessed value read on the sensor. You can select the segment with the up and down arrow keys. You can confirm the segment you want to specify with the PRG key while the sensor is in position for calibration. DONE will appear on the screen for a very short period of time.

Note: During calibration the unprocessed value read from the sensor appears on the second line of the display. Do not confuse this value with a scale value.

6.2.5 Error Message



This error message can only be seen on devices with 4-20mA and 0.5-4.5V inputs. Meaning; The sensor is not connected to the device or the sensor is defective.

6.3 ENTER RELAY SET VALUE

Your device has two relays in total with two contacts, normally open and normally closed. You can use the relay contacts in five different functions depending on your need. These functions are described in 6.4.1

6.3.1 Relay 1 Output Settings (OUT-1)

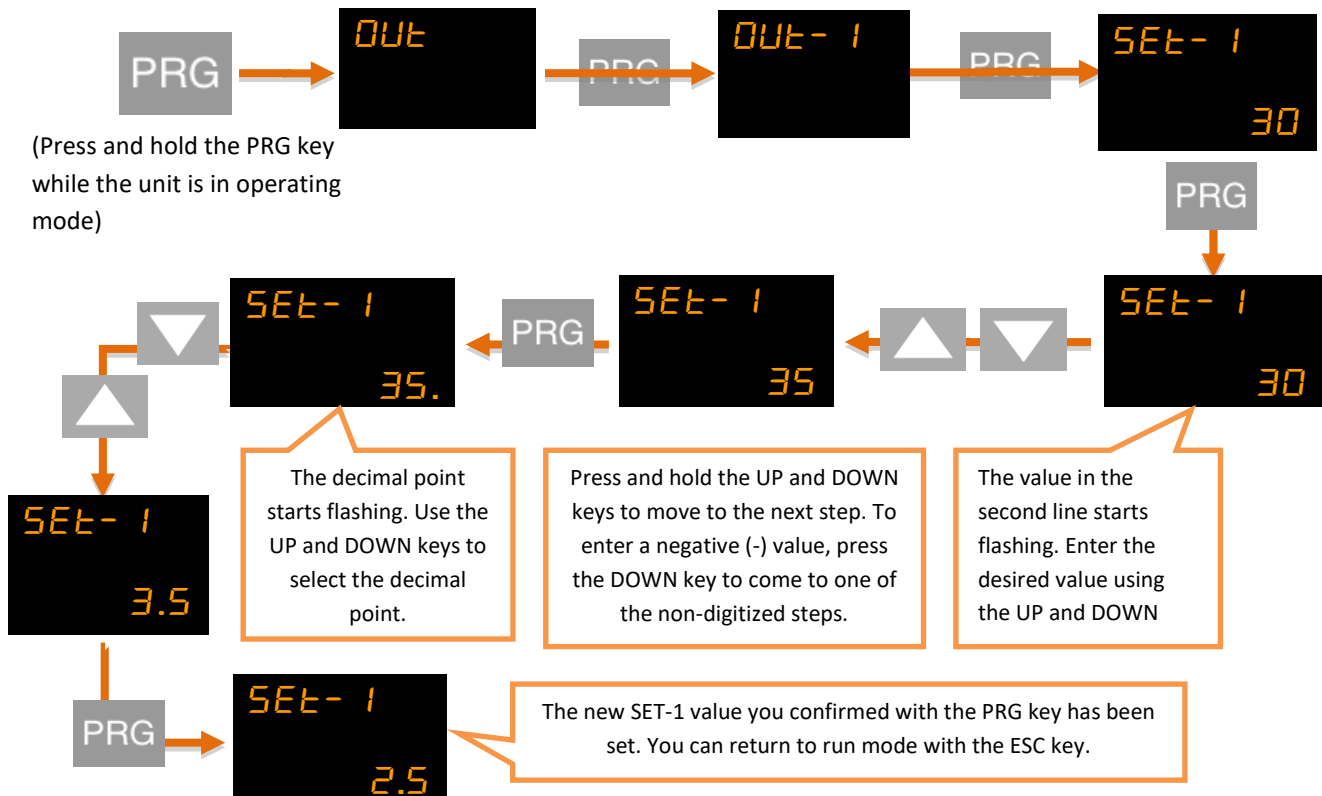

Note: You can also set relay 2 output setting in the same way.

6.3.2 Changing Quick Set Values

Press and hold the ESC key to quickly change all adjustable setpoints while the device is in run mode. You can then change the desired SET value by pressing the PRG key. When entering a value, press and hold the UP and DOWN keys to move to the next step. To enter a negative (-) value, press the DOWN key to come to one of the non-digitized steps.

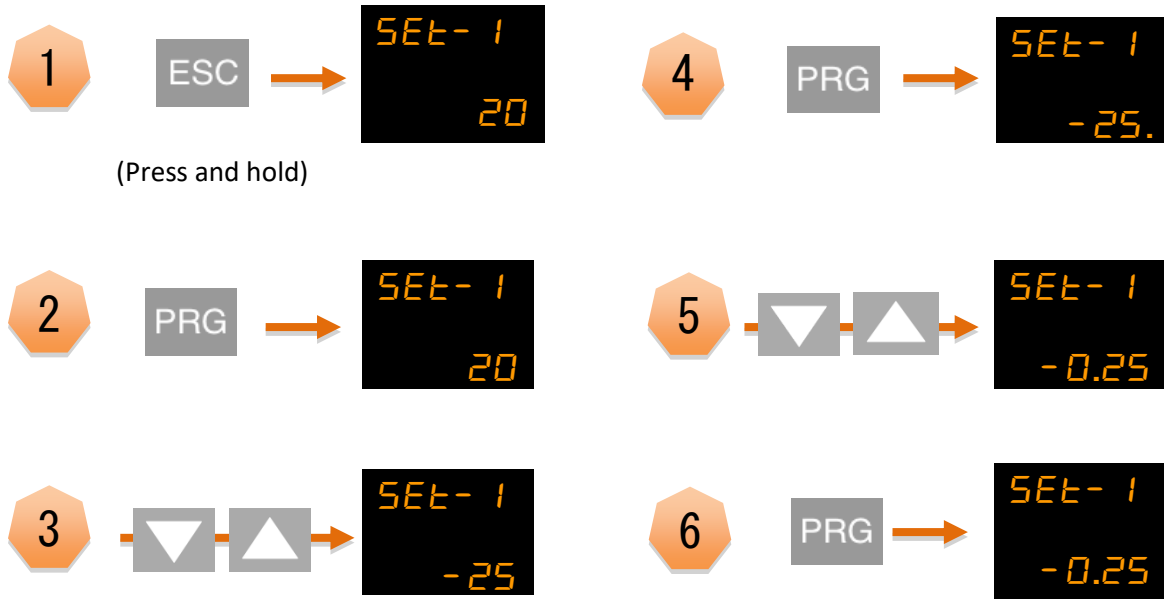

6.4 TRANSITION TO PROGRAMMING MODE

6.4.1 Selection of Relay Function *Funct.*

This function selection determines when the relay output will switch on and switch off according to the set values.

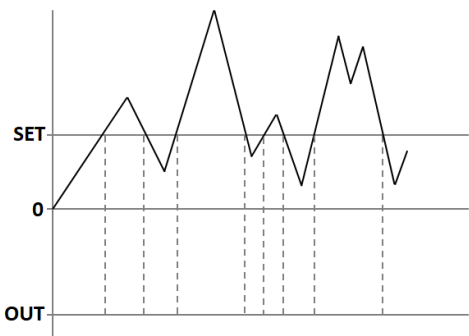

OFF

The relay does not switch off in any way.

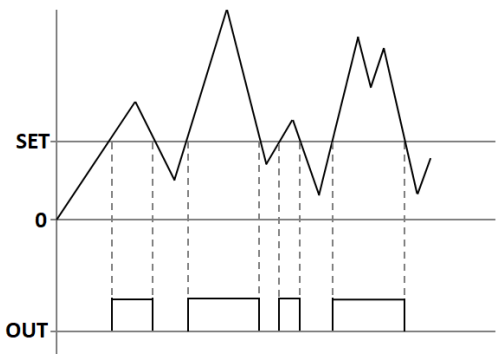

StAnd.

When the value read in the device reaches or exceeds Set-1, the relay switches off.

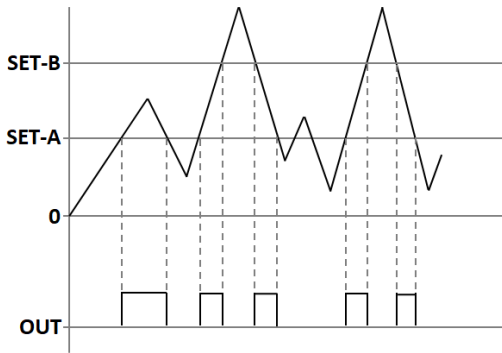

bAnd

When the value read in the device is between Set-1A and Set-1B value, relay switches off

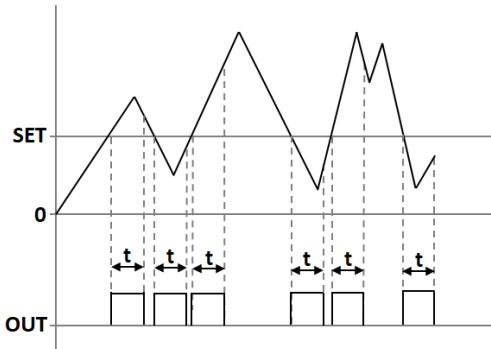

Catch

The value read on the device remains set to the value of Set-1 by increasing or decreasing the value of the relay each time it switches off.

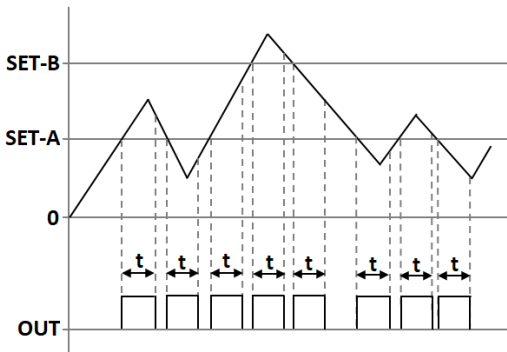

DUAL

The value read in the device remains set to the value set by the set-1A or set-1B value each time the relay

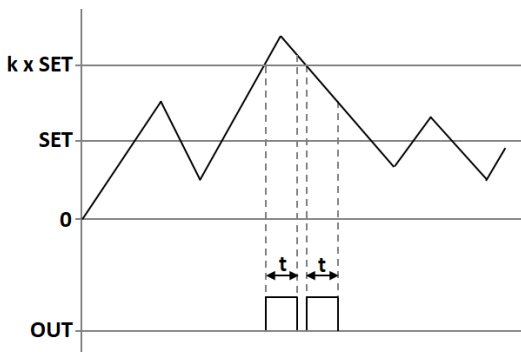

PErdC.

The relay remains switch off until the value entered when the value read in the device passes the Set-1 value or the value of Set-1 at every level such as 2,3,4,5

6.4.2 Delay

The relay specifies in seconds how long it will active and inactive after it is switched off. If '0' is entered as a zero value in the Stand function, the relay will remain switch on unless the relay output condition changes.

6.4.3 Histerezis

Due to the unstability in decimal value read on the connected sensor, you can enter the hysteresis value to prevent the relay from being turned on and off at any time, so that the set value you set for the relay will be activated and inactivated as low as Hysdn and above Hysup.

6.4.4 Offset Value

If you want to add offset to the entered set value, this menu is used. If all set values are selected forward or negative by the specified offset value, they are shifted back.

6.4.5 The Default State of The Relay





Depending on the factory settings of your device, the relay is normally off, so you can change it normally. Use the Cond option for this. The factory setting NC (Normally Closed) means that the relay is normally closed, NO. (Normally Open) indicates that the relay is normally open.

6.4.6 Sensor Selection (Snsor)

*This menu is available in R3.0 and later versions.

Assignment can be done to the selected relay for the sensor types shown below.

Sensor Type:

- | | | |
|---|---|---|
|  | → | When the relay output is wanted to be activated for sensor input, the "DEFAULT" should be selected. |
|  | → | When the relay output is wanted to be activated for Thermocouple or RTD input, the "TEMP" should be selected. |
|  | → | When the relay output is wanted to be activated for CAN-Open communication connection through data-1, the "CAN.dt1" should be |
|  | → | When the relay output is wanted to be activated for CAN_Open communication connection through data-2, the "CAN.dt2" should be |

* You can also set other relay outputs in the same way.

6.5 ANALOG OUTPUT SETTINGS

ANALOG

If your EPA 100, which is specially manufactured according to your order, has analog output module, you can make the necessary settings from this menu.

6.5.1 Analog Output Type Selection

TYPE

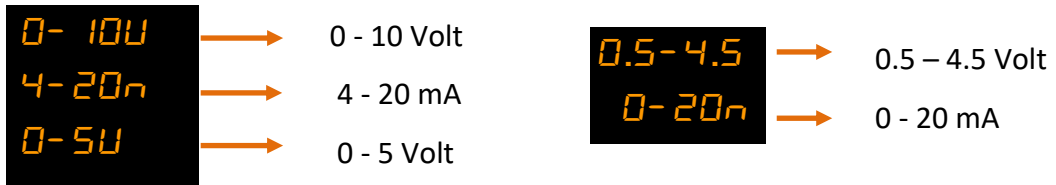

6.5.2 Analogue Output On Off

Cond

Use ON to activate the analog output, OFF to turn it off.

6.5.3 Inverse

Inverse

You can choose which value to increase or decrease according to the sensor reading on the analog output. This option, which is OFF by default, provides an analog output that increases or decreases in proportion to the value read at the sensor. If you turn this ON, the value read out at the sensor will increase while the value at the analog output will decrease, ie an inversely proportional output will be provided.

6.5.4 Analog Output Scale Setting

SCALE

In the device with the analogue output feature, SCALE mode in this menu must be ON to set the output signal to the desired scale range. Then S-LO. and S-HI. values can be entered.

6.6 DIGITAL OUTPUT SETTINGS (COMMUNICATION)

DIGITAL

WARNING: After changing the UART or CANopen settings, you need to restart the device for the changes to take effect.

If your device has a USB port, use MyPanelMeter, which you can download from our website to check your device. Check the user manual of the program.

6.6.1 UART Settings

If you are communicating with your device via RS-485 or RS-232; You can make the necessary settings here. You can select the communication protocol, baudrate, parity, address and period information. For the MODBUS Protocol address information, see the relevant booklet.

6.6.2 CANopen Settings

Here you can set the baud rate, Node ID, Heartbeat, PDO etc. of your device related to CANopen protocol.

For more information on CANopen, see the EPA 100-CANopen booklet.

6.7 SECURE MENU

SECUR

6.7.1 Hide Menu (HIDE)

HIDE

If you don't want to see the operators who will use your device on the menu that you can hide it by.

Hd.ALL



All menus are hidden except for Secure.

Hd.OUT



The Output menu is hidden.

Hd.FOU



The Calib menu is hidden.

Hd.CLb



The display menu is hidden.

Hd.dSP



The Quick Set change menu is hidden. See. 6.4.2

6.7.2 Menu Lock (LOCK)

LOCK

If you have not set a password before, you will see NPASS in the display when you enter this menu. Press the PRG key to set the desired password here. Then use the DOWN and UP keys to select ON the menus you want to lock. The description of menus is the same as in 6.7.1 Menu Hiding section.

6.7.3 Password Determination (PASS)

PASS

Use this menu item to set a password or to change the password you have previously set. If no password was previously set; When you enter this menu, the display will show NPASS. Press the PRG key to set the desired password here. If the password has already been set; The display shows PASS? Will appear and you will be asked to enter this password. After inputting the password, the display will show NPASS. You can specify your new password here and confirm it with the PRG key.

6.7.4 Return to Factory Settings (FTRY)

FTRY

You can return the EPA 100 to its factory settings at any time. Press PRG key to come to this menu to return to the factory settings. Here you are going to face the PASS? You need to enter 12345, which is the factory password, not the user password you specified on the password screen.

6.7.5 Restart the Device (RESET)

In any case, press the PRG key to come back to this menu to restart your device. The device will automatically power off and on and start working.

7. OTHER SETTINGS

7.1 DISPLAY MENU [DISP]

DISP

7.1.1 Decimal Point (Point)

Point

In the value that appears on the display in run mode, you can set the position of the decimal point in this menu. This value, which is '2' in the factory settings, indicates how many digits are displayed after the currency. If you select '0', only the integer appears on the screen.

7.1.2 The Tare Function (Tare)

TARE

In this menu you can specify different Tare functions.

From the EVENT menu you can select the Tare Function type:

Each time the UP button is pressed while the unit is in operation mode, the function of the selected Tare function is:

ZERO



ZERO: Then the value read on the sensor is equal to zero and the **T** status led lights.

PRESET



PRESET: Then the value read on the sensor is equal to the set value and the **T** status led lights.

r.ZERO



REPEATED ZERO: The first time it is pressed, the value read at the sensor is equal to zero and the **T** status led lights. When it is pressed later, the read value returns to the state before the key is activated, and the **T** status led goes out.

r.PRESET



REPEATED PRESET: The first time it is pressed, the value read on the sensor is equalized and the **T** status led lights. When it is pressed later, the read value returns to the state before the key is activated, and the **T** status led goes out.

OFF



Tare function is completely disabled.

7.1.2.1 Tare Input

INPUT

If your EPA 100, which is manufactured specifically for your order, has the Digital Tare Input module, you can make settings from the INPUT menu under the Tare menu.

The EDGE option determines which edge of the edge signal coming from the mode will activate the edge function. RISE for rising edge, FALL for falling edge. For example; When you connect this signal to a button, the RISE option activates the Tare when the button is pressed and the FALL option when the button is released. In the FILTR option, you can specify the number of milliseconds after which the modulated signal is to be checked. By default, this value is 100 ms.

7.1.3 Viewing the Max and Min Values That Are Read (Peak) **PEAK**

*This menu is available in R3.0 and later versions.

If you press the DOWN key while the unit is in operating mode, you can see the lowest (minimum) value read from the moment the unit starts to operate. When you press the DOWN key again, you can see the highest (maximum) value read from the moment the device starts to operate.

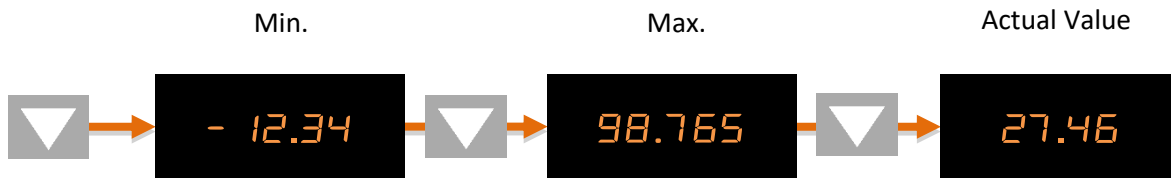

* You can see Min - Max on the screen for as long as you want and make it active for as long as you want. To make settings for Min – Max menu;



- t.Lo.** → A value in seconds is entered and the last minimum value is kept on the display for this time. If no value is entered in this menu, the minimum value in memory is valid.
- t.H.** → A value in seconds is entered and the last maximum value is kept on the display for this time. If no value is entered in this menu, the maximum value in memory is valid.
- t.ESC.** → A value in seconds is entered, min. or max. values are kept on the display for the time entered. then the screen returns to the current value. If no value is entered in this menu, min. or max. value remains visible on the screen.

Note: You can use the ESC key to delete the (minimum) or (maximum) values in the memory.

7.1.4 Screen Refresh Rate (REFRS) **REFRS**

Indicates how many milliseconds the value displayed on the screen will be refreshed. By increasing this value, which is 100 ms by default, you can avoid or reduce the unstability on the screen, reducing the time it takes your device's sensor to react.

7.1.5 Preventing Unstability on the Screen (FILTR) **FILTR**

The EPA 100 is programmed to show the signals received from the sensor connected to it in the most accurate way by processing them with special algorithms. But; You may be able to solve this problem with the value tremble filtering method which appears on the screen for a variety of reasons such as noise in the vicinity, disturbances in the sensor. There are three different filtering methods for this. As you can use these filtering methods alone, you can use both filters together.

1. AVRGE (Average Calculation):

When you activate this filter by turning the STATE option ON, your device will refresh the value that appears on the display after you have read as many values from the sensor as you would select COUNT. For example; When COUNT is 500, your device will refresh the value on the screen after you have sampled 500 times from the sensor, that is, after reading it, taking the average of these values. Accordingly, increasing COUNT will reduce flicker on the screen; But your device will slow the response of the sensor to its rapid movement.

2. LQE(Linear Quadratic Estimation):

You can also activate this filter, also known as a thick filter, by turning the STATE option ON. If you decrease the default COVARIANCE of 500, the screen flicker will decrease; But your device will slow down the reaction of the sensor to its rapid movement.

3. Hysteresis Filter:

You can activate the hysteresis filter by turning the STATE option ON. With this filter, which has two parameters named Delta and A.Error, the unprocessed value read from the sensor is not reflected on the screen until it changes to Delta. When the sum of the unprocessed values reflected on the screen is equal to A.Error, the display is updated with the average of these values.

7.1.6 Second Line Identification on the Screen LAbEL

When the device is in operating mode, the first line contains the value read from the sensor; The second line is empty by default. In the second line you can type the desired parameter or type in this menu. Parameter options; Set values of the relays (SET-1 and SET-2), Preset value (PRSET) determined for the function. You can also choose one of the fixed font options such as various units, label number.



7.1.7 Keypad Setting (SOUND) Sound

When you press any key on your device, you can turn the beep sound on and off from this menu. Use ON to turn on the sound, OFF to turn it off.



8. OPERATION MODULE FUNCTIONS

Your EPA 100 process controller runs in two different modes. Your device is in 'operating mode' while the initial value of the sensor readout is displayed; In the 'programming mode' on the screen where the settings are changed and the parameters are changed. In this section, the functions in operating mode are explained.

8.1 TARE FUNCTION

**** Only works when the Tare function is active. For activating or explaining the types of functions, 7.1.2 Setting the Tare Function*

Each time the UP key is pressed while the unit is in operation mode, Tare is activated according to the type of the selected function and **T** status led lights.

8.2 VIEWING THE MAXIMUM AND MINIMUM READ VALUES

If you press the DOWN key while the unit is in operating mode, you can see the lowest (minimum) value read from the moment the unit starts to operate.

When you press the DOWN key again, you can see the highest (maximum) value read from the moment the device starts to operate.



Note: You can use the ESC key to delete the (minimum) and (maximum) values in the memory.

9. PRODUCT CODING

When ordering your EPA 100 process controller, you can use the following coding format.

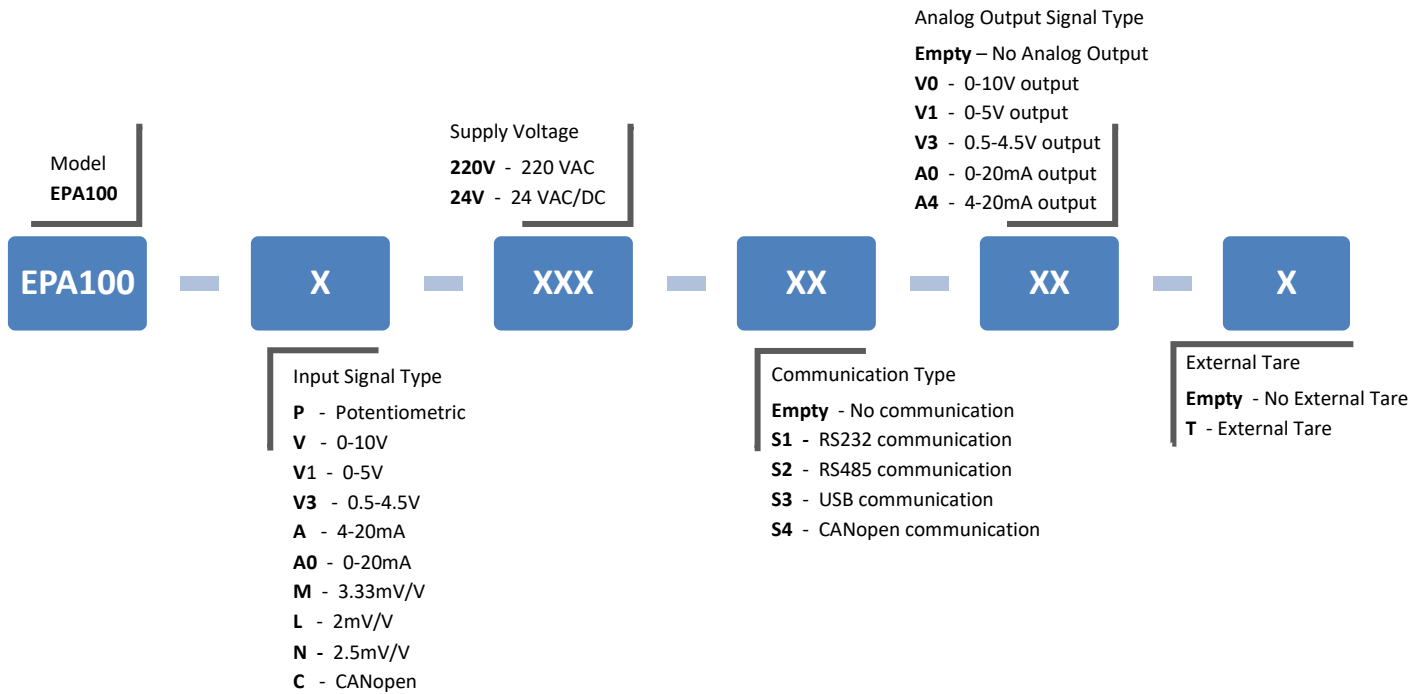

*If the input signal type is selected as mV/V (M, L, N), the analog output signal (V0, V1, V3, A0, A4) cannot be received.

10. WARRANTY DOCUMENT

Seller Company's:

Name:

Address:

Phone:

FAX:

E-mail:

Invoice Date and No:

Delivery Date and Address:

Signature, Cachet

Product Brand: ATEK

Product Code: EPA-100

Serial No:

Warranty Time: 2 Years

This product is guaranteed for 2 years against manufacturing defects.

Non-warranty situations:

- Mechanical damages
- Damages in case of transportation
- User errors

Other cases than these cases are under the manufacturer's warranty.