

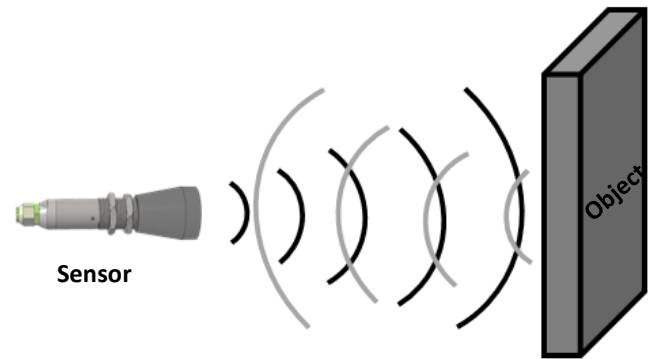

The ultrasonic sensors send and detect high-frequency ultrasonic sound with a piezoelectric transducer. A part of the reflected sound wave by hitting the measuring surface is detected by the transducer, depending on the speed of the signal in the air, the distance of the objects is determined. When the specified switching point is reached, the output is switched. The measured value is given as analog (0 ... 10 V, 0...20 mA, 4 ... 20 mA) or CANopen signal.

With ultrasonic sensors, objects can be reliably detected and measured regardless of material, color, transparency and surface properties.

ULT series ultrasonic sensors, designed and manufactured by Atek Sensors R&D engineers, are used in contactless and level measurements of liquid and solid materials in open and closed tanks. It is very easy to install with its small body structure.



### GENERAL FEATURES

- Ultrasonic working principle
- Different measuring options up to 6 meters
- Acid-proof option
- Non-contact and high precision measurement
- $\pm 0.2\%$  FS accuracy
- RS-232, RS-485, CANopen serial connection options
- 4-20 mA, 0-20 mA, 0-10V analog output options
- 2 pcs switch output (PNP open collector)
- IP67 high protection class
- Small structure
- Economical and maintenance-free design
- Easy installation

### APPLICATION AREAS

- Level measurement, pump control in tank, warehouse etc.
- Occupancy rate calculation in product warehouses
- Treatment plants
- Food industry
- Chemical industry

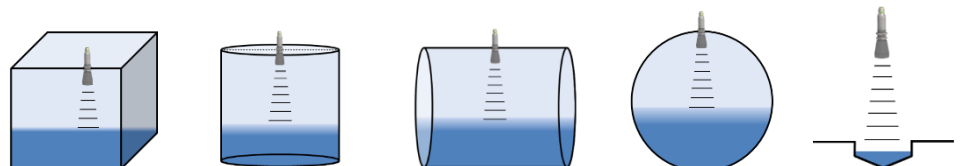

## TECHNICAL SPECIFICATIONS



MODEL	ULT30-40	ULT30-75	ULT30-75A
<b>Max working distance</b>	6000 mm	4000 mm	2000 mm
<b>Blind zone</b>	400 mm	200 mm	200 mm
<b>Frequency</b>	40 kHz	75 kHz	75 kHz
<b>Angle</b>	30°	12°	12°
<b>Acid Proof</b>	X	✓	✓ (strong acid)
<b>Housing material</b>	316L, Delrin	316L, Delrin	Teflon
<b>Accuracy</b>	±%0.2 FS		
<b>Supply voltage</b>	16...30 VDC		
<b>Power consumption</b>	2,4 Watt max.		
<b>Current consumption</b>	100 mA max. @24 VDC / 150 mA max. @16 VDC		
<b>Sampling rate</b>	4 Hz		
<b>Minimum resolution</b>	1 mm		
<b>Switch outputs (optional)</b>	2 x PNP Open Collector		
<b>Serial communication (optional)</b>	RS-232, RS-485, CANopen		
<b>Analog outputs (optional)</b>	0-20 mA, 4-20 mA, 0-10 V, 0.5- 4.5 V, 0-5 V 20-0 mA, 20-4 mA, 10-0 V, 4.5-0.5 V, 5-0 V		
<b>Analog output load</b>	500 Ω		
<b>Analog output resolution</b>	16 Bit (better than 1 mm)		
<b>Reverse connection protection</b>	Yes		
<b>Temperature compensation</b>	Yes		
<b>Watchdog</b>	Yes		
<b>Electrical connection</b>	M12 / 8 pin male or M12 / 5 pin female connectors (standard) 8 x 0,14 mm <sup>2</sup> shielded cable or 5 x 0,14 mm <sup>2</sup> shielded cable (optional)		
<b>Cable length</b>	Standard 1m, Optional other lengths		
<b>Operating temperature</b>	-40 °C ... 75 °C		
<b>Storage temperature</b>	-40 °C ... 85 °C		
<b>Protection class</b>	IP67		
<b>Weight</b>	~400 gr		

### RS-232 / RS-485 SPECIFICATIONS

<b>Communication Protocols</b>	ASCII, Modbus RTU, Modbus ASCII Default: Modbus RTU
<b>Baud Rate</b>	600, 1200, 2400, 4800, 9600, 14400, 19200, 38400, 57600, 115200 Default: 9600
<b>Parity</b>	None, Odd, Even Default: None
<b>Address</b>	Between 1 and 247 Default: 1

## CANopen SPECIFICATIONS

<b>Communication Profile</b>	CiA 301
<b>Response Frequency</b>	100 Hz.
<b>Device Type</b>	CANopen, CiA 301
<b>Node ID</b>	Between 1 and 127, configurable via LSS or SDO.
<b>Baud Rate</b>	10 kBit/s, 20 kBit/s, 50 kBit/s, 100 kBit/s, 125 kBit/s, 250 kBit/s, 500 kBit/s, 800 kBit/s, 1 Mbit/s
<b>PDO Data Rate</b>	100 ms
<b>Error Check</b>	Heartbeat, Emergency Message
<b>PDO</b>	1 Tx PDO
<b>PDO Modes</b>	Event/Time triggered, Synch/Asynch
<b>SDO</b>	1 server
<b>Position data</b>	Object Dictionary 6004
<b>Terminating Resistor</b>	Optional

## MECHANICAL DIMENSIONS (in mm)

### ULT30-40

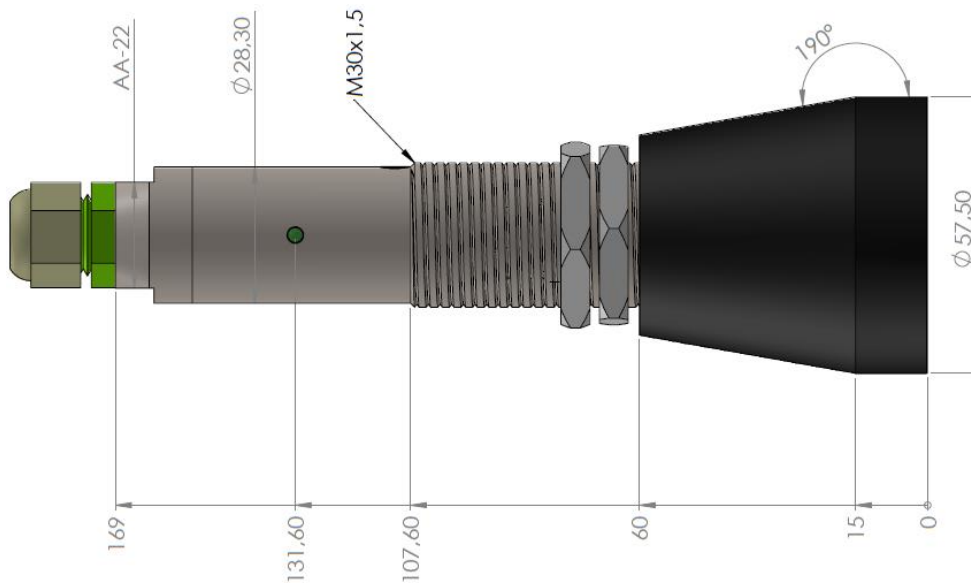

### ULT30-75 / ULT30-75A

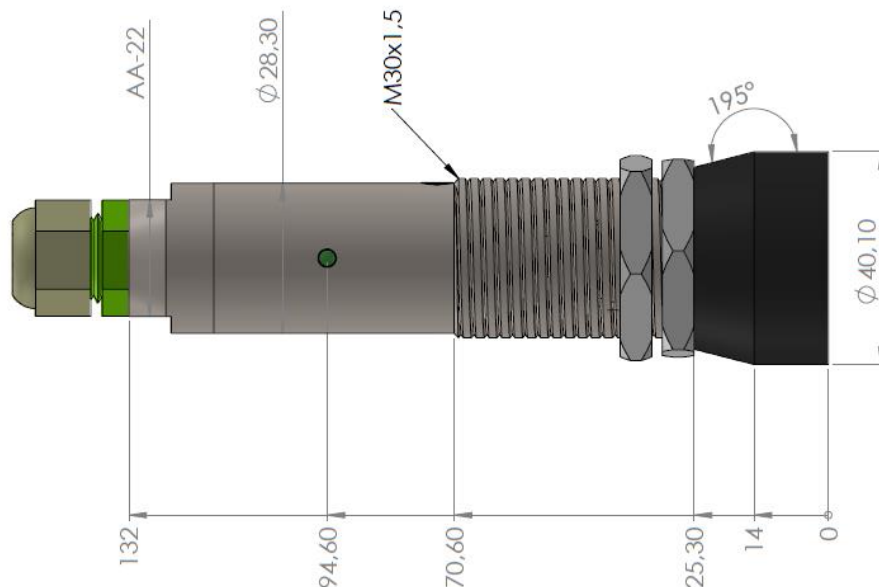

## ELECTRICAL CONNECTIONS

### CN1 (M12 / 8 Pin connector or 8x0,14 mm<sup>2</sup> cable)

Pin No	Signal	Cable Color
1	16..30VDC Supply input	Red
2	GND – 0V	Black
3	Analog Out -	Green
4	Serial Communication (RS232 - Tx) (RS485 - B) (CAN - L)	Blue
5	Serial Communication (RS232 - Rx) (RS485 - A) (CAN - H)	White
6	Analog Out +	Yellow
7	Open Collector Output 1	Grey
8	Open Collector Output 2	Pink

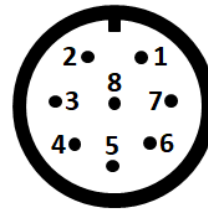

**M12/8 Pin male connector**  
(front view of the connector on the sensor)

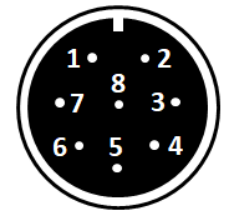

**M12/8 Pin female connector**  
(front view of the cable-mounted connector)

### CN2 (M12 / 5 Pin connector or 5x0,14 mm<sup>2</sup> cable)

Pin No	Signal	Cable Color
1	16..30VDC Supply input	Red
2	GND – 0V	Black
3	Analog Out +	Yellow
4	Analog Out -	Green
5	N/C	Pink

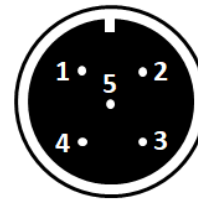

**M12/5 Pin female connector**  
(front view of the connector on the sensor)

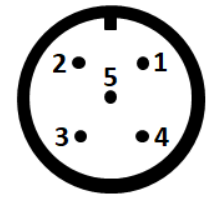

**M12/5 Pin male connector**  
(front view of the cable-mounted connector)

## MOUNTING

### Measuring Distance and Angle

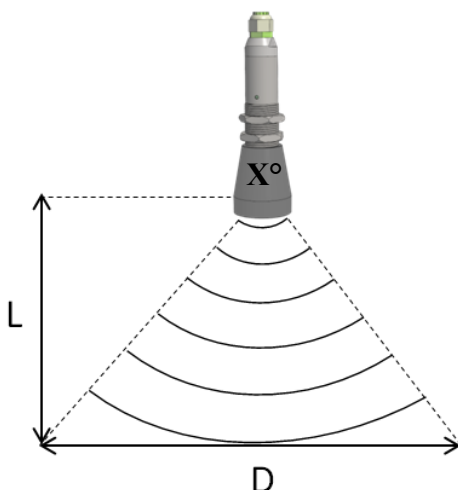

L	ULT30-40		ULT30-75, ULT30-75A	
	30°		12°	
	OPTIMUM	MINIMUM	OPTIMUM	MINIMUM
	D		D	
1m	60 cm	60 cm	20 cm	15 cm
2m	110 cm	80 cm	35 cm	25 cm
3m	160 cm	110 cm	55 cm	50 cm
4m	220 cm	130 cm	70 cm	60 cm
5m	270 cm	140 cm	-	-
6m	330 cm	150 cm	-	-

L indicates the mounting height and there should be no obstacle which blocks signals in D width. These values are optimally included in the table above. If optimum dimensions are not followed, level measurement is made, but measurement accuracy decreases.

If it is not possible to install in optimum dimensions, the minimum dimensions must be followed.

## Mounting Warnings

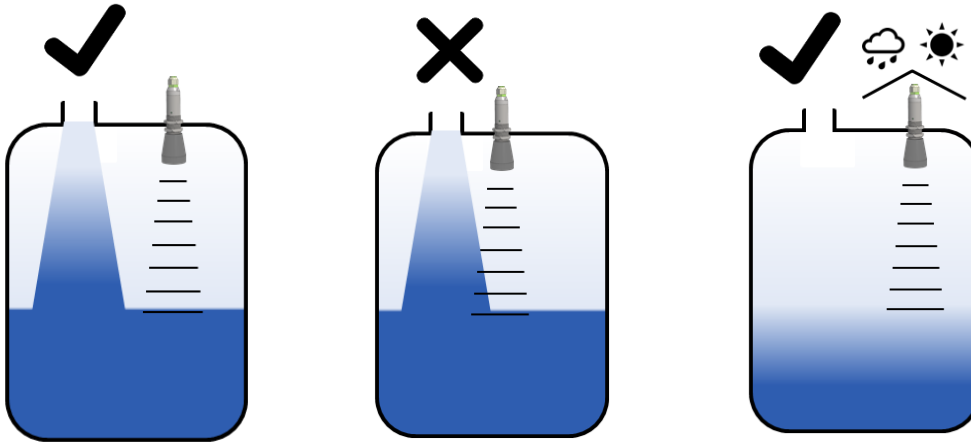

- For level measurement, the sensor must not be installed near the tank input.
- It is recommended that the sensor be protected against sun and rain.

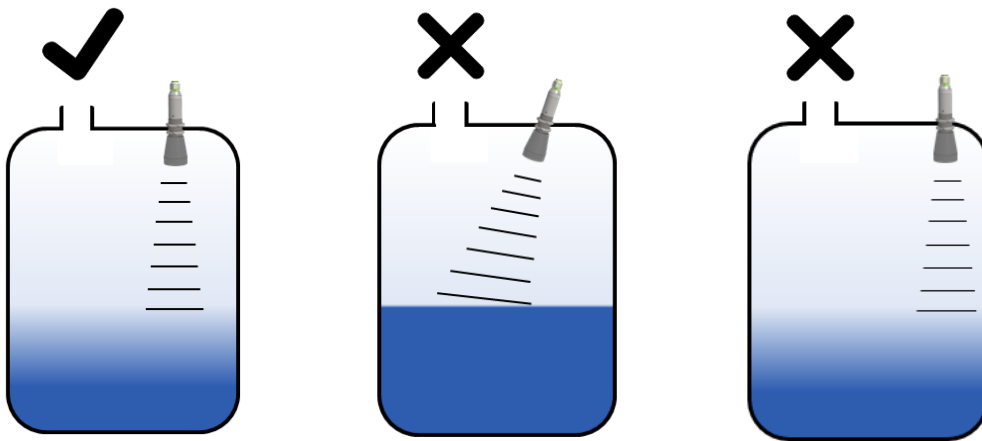

- The sensor must be installed perpendicular to the surface to be measured and should not be placed close to the side surface.

## LED FUNCTION

There is 1 LED indicator on the device. This LED color and blinking speed changes depending on normal operation, error and configuration situations.

**Normal Operating Status:** When the device is in normal operating mode, the LED indicator flashes green once per second.

**Error Status:** If the device is in error status, the LED blinks red once a second. (See page 10: Error Reasons)

**Configuration Status with Magnet:** While the device is configured with a magnet, when it starts to detect the magnet, the LED color changes depending on the setting menu it is in (analog output or switch setting). LED color indicates which setting menu you are in and which setting can be made. As long as the magnet is detected, the blinking speed of the LED increases, flashing 10 times per second. Blinks for one second unless the magnet is detected.

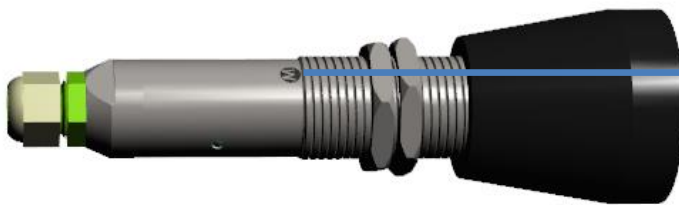

The zone where the adjustment magnet is approached

**1. Setting the analog output minimum point:**

Depending on the product output type, the distance at which the analog minimum value will be given is set. When the device is in Normal Operation mode, the magnet is held to the magnetic reader area while the Green LED flashes for one second. If the magnet is detected, the sign LED starts to emit white light. If the magnet is held for more than 5 seconds, the device enters the menu where the analog minimum set point will be adjusted. In this case, the indicator LED starts to blink red and at one-second intervals.

Operations that can be done while in this menu:

**-Setting the analog minimum point at the desired distance:** ULT is positioned at the position where the minimum analog output is desired. The magnet is read for a period of time greater than 1 second and less than 5 seconds.

**-Going to the next menu:** The magnet is read for more than 5 seconds. If the analog minimum point is not set at this stage, the point that was previously set as the analog minimum point will be valid. If the user enters the settings menus, he can exit without making any adjustments.

**-Loading factory settings:** If the magnet is read for more than 20 seconds, it restores the analog minimum, analog maximum, switch point1, switch point2 points made when the device was delivered to the user. The device exits the settings menus and returns to normal operating mode.

**2. Setting the analog output maximum point:**

Depending on the product output type, the distance at which the analog maximum value will be given is set.

If the magnet is read for more than 5 seconds and less than 15 seconds while the sign LED is red and flashing at one-second intervals, this menu is entered. The indicator LED starts blinking green and at one-second intervals.

Operations that can be done while in this menu:

**-Setting the analog maximum point at the desired distance:** ULT is positioned at the position where the maximum analog output is desired. The magnet is read for a period of time greater than 1 second and less than 5 seconds.

**-Inverting the analog output:** If the magnet is read for more than 20 seconds, it gives the analog maximum value (e.g. 20mA) at the minimum range point (e.g. 0 meters) and the analog minimum value (e.g. 4mA) at the maximum range point (e.g. 4 meters).

**-Going to the next menu:** The magnet is read for more than 5 seconds. If the analog maximum point is not set at this stage, the point that was previously set as the analog maximum point will be valid. If the user enters the settings menus, he can exit without making any adjustments. If there are no Switch outputs on the device, it returns to normal operating mode after this menu.

**ANALOGUE OUTPUT SCALE SETTING - SAMPLE SIGNAL OUTPUT**

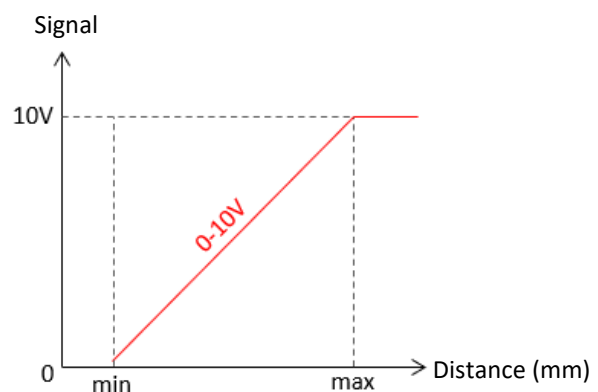
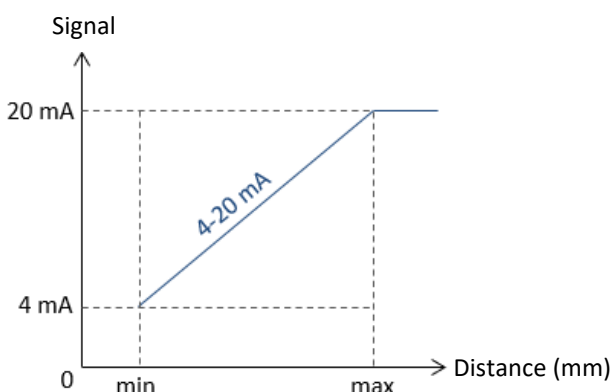

### 3. Setting Switch Out point 1:

If the device does not have Switch outputs (PNP Open Collector outputs), the device goes to normal operating mode instead of this menu.

In this menu, the distance at which the 1st Switch point of the product will be switched is set.

If the magnet is read for more than 5 seconds and less than 15 seconds while the sign LED is green and flashing at one-second intervals, this menu is entered. The indicator LED starts blinking blue and at one-second intervals.

Operations that can be done while in this menu:

**-Setting Switch Out 1 switching point:** ULT is positioned at the position where it is desired to give output. The magnet is read for a period of time greater than 1 second and less than 5 seconds.

**-Going to the next menu:** The magnet is read for more than 5 seconds. If the Switch Out 1 switching point is not set at this stage, the point that was previously set will be valid.

### 4. Setting Switch Out 2 point:

In this menu, the distance at which the 2nd Switch point of the product will be switched is set.

If the magnet is read for more than 5 seconds and less than 15 seconds while the sign LED is blue and flashing at one-second intervals, this menu is entered. The indicator LED starts blinking turquoise and at one-second intervals.

Operations that can be done while in this menu:

**-Setting Switch Out 2 switching point:** ULT is positioned at the position where it is desired to give output. The magnet is read for a period of time greater than 1 second and less than 5 seconds.

**-Going to the next menu:** The magnet is read for more than 5 seconds. If the Switch Out 2 switching point is not set at this stage, the point that was previously set will be valid.

**Warning(!) If a magnet is brought close to the magnetic reader area and the indicator LED does not start blinking fast, it means that the magnet is not detected. It should be tried by changing the direction of the magnet, or if the magnet is a weak magnet, it should be tried with a stronger magnet.**

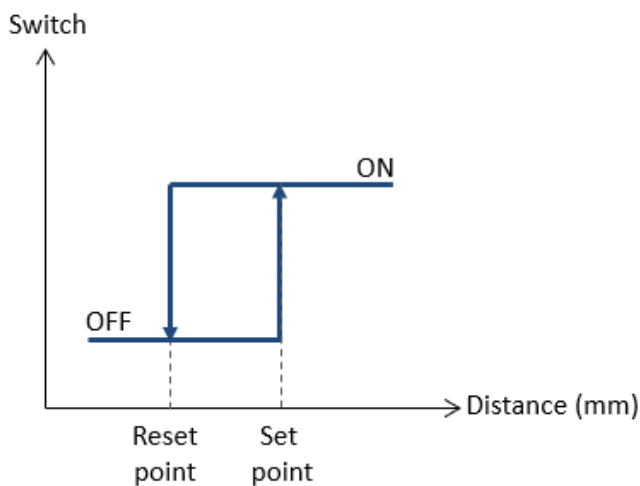

Hysteresis = %1 FSR

For example; for the sensor which has 4000 mm distance;

Hysteresis =  $4000 / 100 = 40$  mm

# CONFIGURATION FLOWCHART

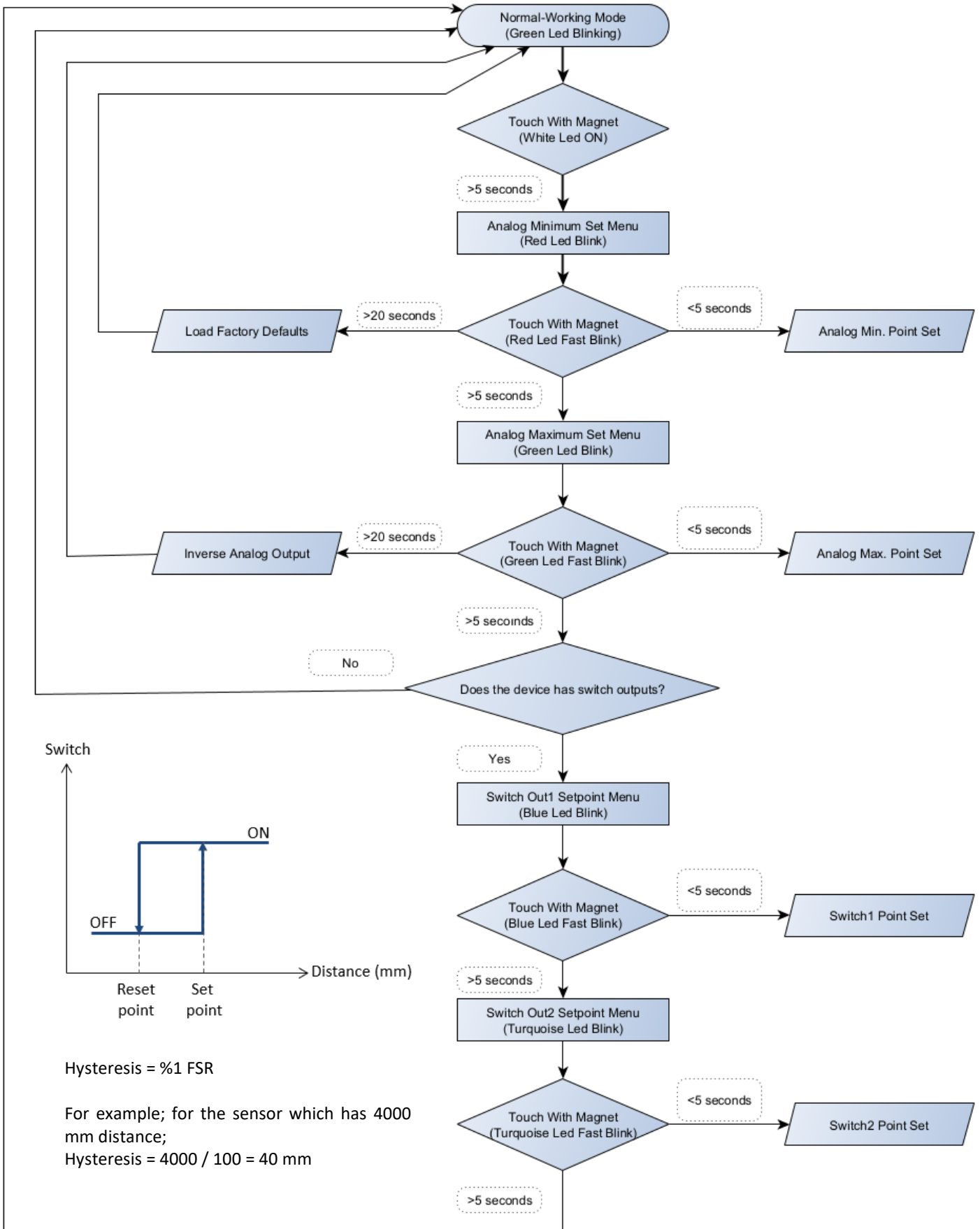







## ORDER CODE

<b>Model</b> ULT30-40 ULT30-75 ULT30-75A	<b>Max. Measuring Range</b> 2000 mm (ULT30-75A) 6000 mm (ULT30-40) 4000 mm (ULT30-75) Can be selected up to distances above.	<b>Digital Output</b> No code: No digital output C: CANopen S1: RS-232 S2: RS-485	<b>Electrical Connection <sup>(2)</sup></b> S14M: M12/8 pin male S13F: M12/5 pin female 1M: 1 meter cable (*optional other lengths)
<b>ULT30-XXX</b>	<b>XXX</b>	<b>XXXX</b>	<b>XX</b>
<b>Housing Material<sup>(1)</sup></b> M: 316L stainless steel D: Delrin (acid-proof) T: Teflon (strong acid-proof, only for ULT30-75A)		<b>Analog Output</b> No code: No analog output V0 : 0-10 VDC V1 : 0-5 VDC V3 : 0.5-4.5 VDC A0 : 0-20 mA A4 : 4-20 mA  NV0 : 10-0 VDC NV1 : 5-0 VDC NV3 : 4.5-0.5 VDC NA0 : 20-0 mA NA4 : 20-4 mA	<b>Switch Output</b> No code: No switch output OCP: 2 x PNP open collector

- (1) Housing Material:  
 ULT30-40:316L, ULT30-75:316L or Delrin, ULT30-75A:Teflon can be selected.
- (2) The product can be requested with cable or connector. In models with socket; S13F code socket should be selected only when product with analog output is desired. If different outputs are desired in addition to analog output, S14M code socket should be selected. ULT30-75A product is only produced with cable in terms of acid resistance. Only analog output can be selected in the ULT30-75A.

## OPTIONAL PRODUCTS

Product	Code	Description
	S14F	M12/8 pin female connector (IP67) (For connection with M12/8 pin male connector on the sensor)
	S13M	M12/5 pin male connector (IP67) (For connection with M12/5 pin female connector on the sensor)
	CB8 XM / S14F	X meters 8x0,14 mm <sup>2</sup> extension cable + M12/8 pin female connector (IP67) X = Max. 50 meters
	CB5 XM / S13M	X meters 5x0,14 mm <sup>2</sup> extension cable + M12/5 pin male connector (IP67) X = Max. 50 meters

Atek Elektronik Sensör Teknolojileri Sanayi ve Ticaret A.Ş.



Gebze OSB, 800. Sokak, No:814 Gebze/KOCAELİ/TURKEY



Tel: +90 262 673 76 00



Fax: +90 262 673 76 08



[www.ateksensor.com](http://www.ateksensor.com)



[Info@ateksensor.com](mailto:Info@ateksensor.com)