



- Piezoresistive measurement principle
- Long-term stable operation
- EMC and Reverse Polarity protection
- 4-20 mA or 0-10 V analog output
- Different level measuring between 1 meter and 100 meters
- 19 mm slim body
- IP68 protection class
- High quality
- Reasonable price, economical solution

PTL 190 level pressure sensors with piezoresistive working principle; are used for level measurement in applications like streams, reservoirs, water tanks etc. With its stainless steel housing with IP68 protection class, it can work in harsh environments.

Thanks to the surge voltage and reverse polarity protection, the PTL 190 series are unaffected by electrical fluctuations and reverse connections.

Optionally configurable pressure ranges, analog output and mechanical connection options offer solutions suitable for various applications.

TECHNICAL SPECIFICATIONS

| | | | | |
|-----------------------------|--|-----------------------|------------------------------|---|
| Measuring Range | Different models between 100 mbar and 25 bar can be selected | | Electrical Connection | 3 x 0,22 mm ² cable Cable outer diameter: 7,5 ±0,2 mm Drain pipe diameter: 2 mm (Cable length according to level value) |
| Measuring Principle | Piezoresistive | | Operating Temperature | -20°C ... +70°C |
| Membrane | 1.4404 (AISI 316L) | | Storage Temperature | -20°C ... +70°C |
| O-Ring | Viton (FKM) | | Protection Class | IP68 |
| Maximum Pressure | %200 FS | | Material | Body: 1.4404 (AISI 316L stainless steel) Cable: PE (polythene) |
| Precision | %0,3 | | Weight | ~300 gr |
| Electrical Interface | Output Signal | Supply Voltage | EMC Protection | Emission: EN/IEC 61000-6-3 Immunity: EN/IEC 61000-6-2 |
| | 0...10 VDC (3 wire) | 12...30 VDC | | |
| | 4...20 mA (2 wire) | 8...32 VDC | | |

ELECTRICAL CONNECTION

4-20 mA Connection

| Signal | Cable |
|------------------------|-------|
| +8...32 VDC (+ supply) | Red |
| 4-20 mA | Black |

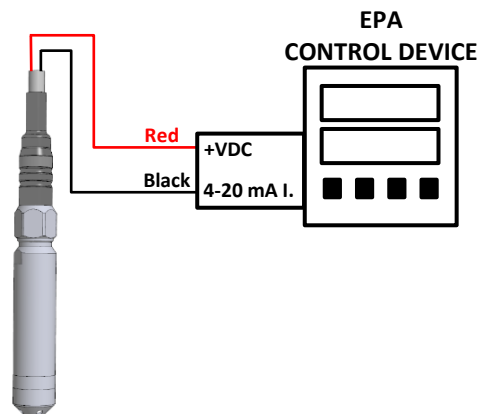
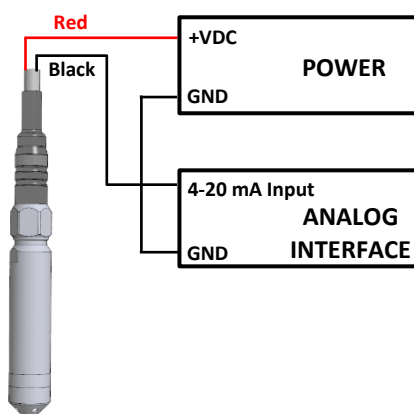

0-10 VDC Connection

| Signal | Cable |
|-------------------------|--------|
| +12...30 VDC (+ supply) | Red |
| GND | Black |
| 0-10 VDC | Yellow |

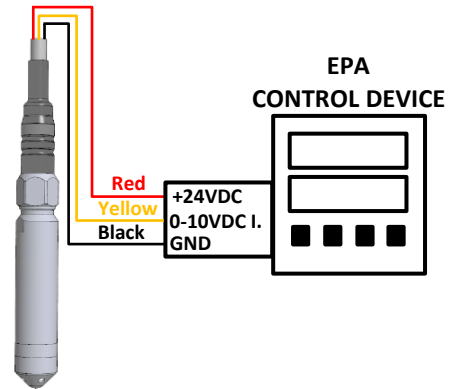
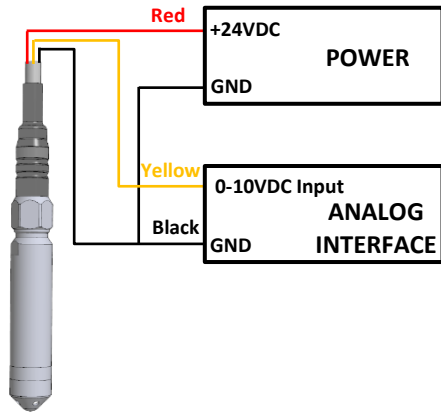

WARNING!

If the wick in the drain pipe is removed, the product will be out of warranty.

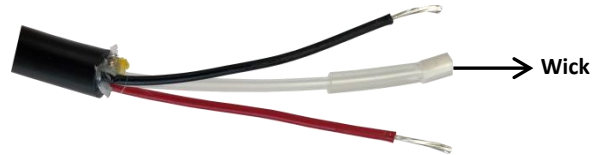

SAMPLE APPLICATION

During the application, the product free submerge. Dams, rivers and streams of the product against a surge in applications should be suspended through the pipes.

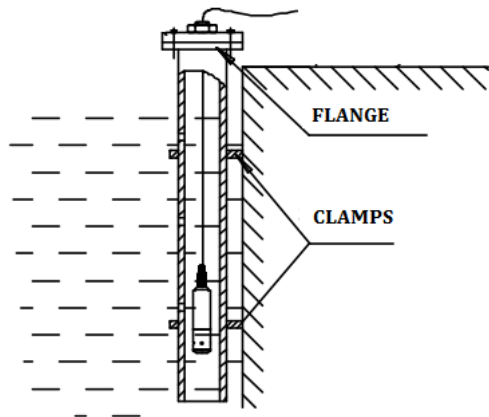
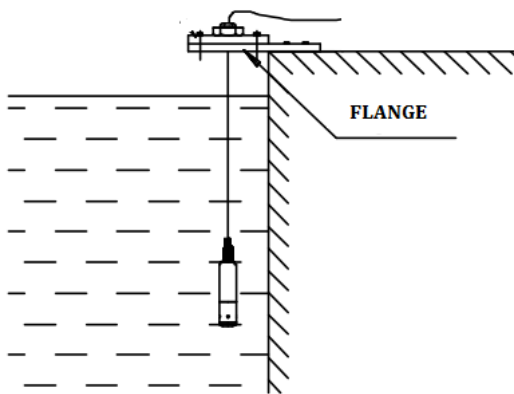

MECHANICAL DIMENSIONS (mm)

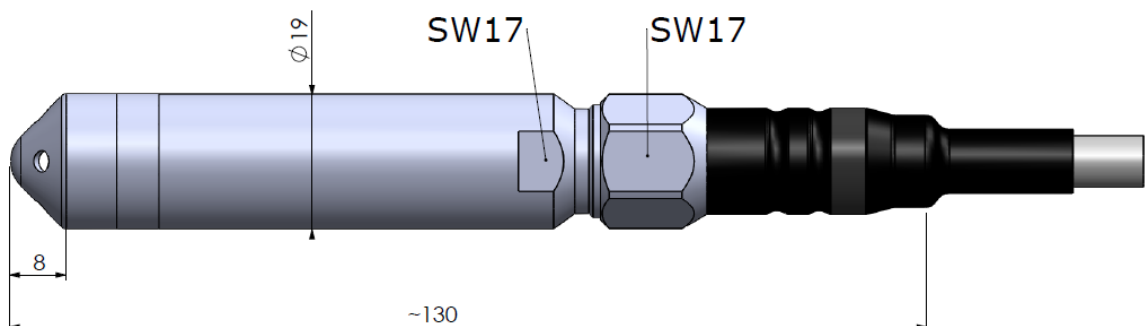

SAMPLE APPLICATION FIELDS

- Wells
- Water Tanks
- Lake Level

- River Level
- Reservoirs



ORDER CODE

Model

PTL 190

XXXX

Output Signal

V : 0-10 VDC
A : 4-20 mA

X

XXX

Pressure

Different models between 100 mbar and 25 bar can be selected

*(For water, 1 meter level = 100 milibar)

Cable Length

5M : 5 meters

8M : 8 meters

10M: 10 meters

* Must be selected 1 meter above the value to be measured in liquid level

Atek Elektronik Sensör Teknolojileri Sanayi ve Ticaret A.Ş.



Gebze OSB, 800. Sokak, No:814 Gebze/KOCAELİ/TURKEY



Tel: +90 262 673 76 00



www.ateksensor.com



Fax: +90 262 673 76 08



info@ateksensor.com