

AWP 740

“Analog or CANopen Output,
High Accuracy, High Measuring Length”

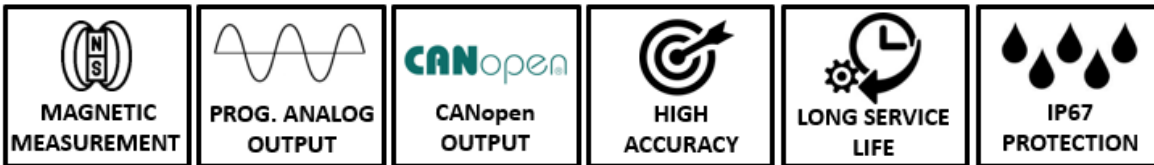
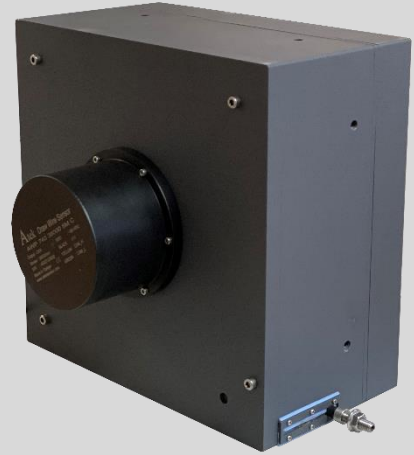

- Measuring length up to 40.000 mm
- Magnetic absolute measurement technology
- Robust stainless steel measuring wire
- Aluminium housing
- Analog or CANopen output
- Programmable analog output option
- IP67 protection class
- Compact design and easy mounting
- 1 m/s maximum movement speed
- Shock/vibration resistant

MECHANICAL DATA

Measuring Range (stroke)	40.000 mm
Max. Movement speed	1 m/s
Extension Force	14N
Protection Class	IP67
Operating Temperature	-40°C...+85°C
Material	Body: Aluminium
	Measuring wire: Stainless steel

MECHANICAL DIMENSIONS (mm)

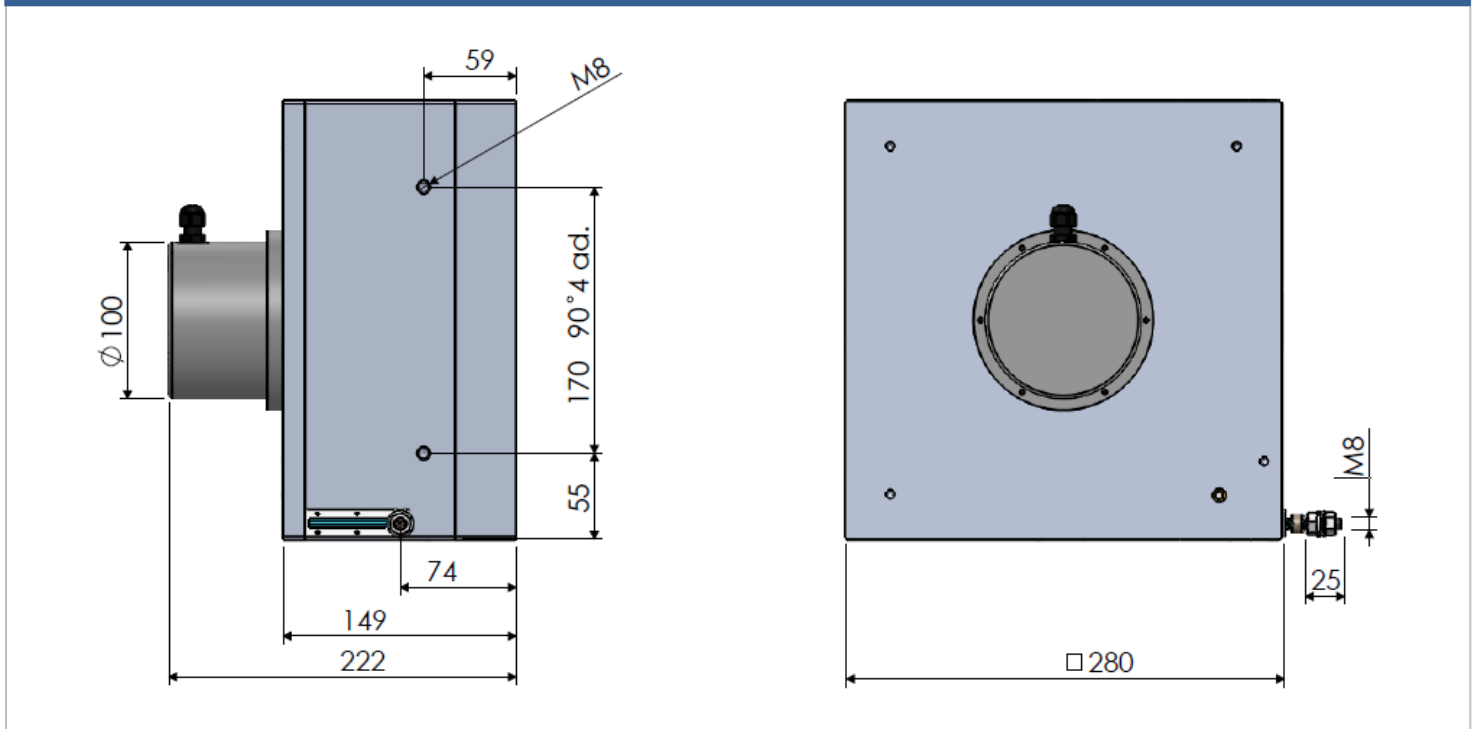

ANALOG VERSION

Electrical Specifications

Measuring range	Up to 40.000 mm
Supply voltage	15...26 VDC
Current consumption	≤60 mA
Reverse polarity protection	Yes
Short circuit protection	Yes (only supply)
Response frequency	500 Hz
Resolution	0.05 mm
Linearity	±%0.5 FS
Output signal	Voltage: 0-10V, 0.5-4.5V, 0-5V Current: 4-20 mA
Signal characteristics	Increasing (exmp: 4-20 mA) Decreasing (exmp:20-4 mA)
Sensing device	Magnetic absolute encoder
Electrical connection	M12 connector or cable

Electrical Connection

Signal	Cable	M12 / 5 pin male connector
V+ (15...26 VDC)	Red	Pin 1
Analog output signal	Yellow	Pin 2
GND	Black	Pin 3
N/C	Green	Pin 4
N/C	Pink	Pin 5

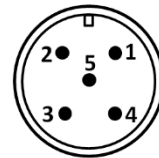

Order Code

Electrical Connection

S13M: M12/5 pin male connector
2M: 2m cable
 *Optional others

Model

AWP 740	-	XXXX	-	XXXX	-	XX
---------	---	------	---	------	---	----

Measuring Range

Up to 40.000 mm

Analog Output Signal

- V : 0-10 VDC
- V1 : 0-5 VDC
- A : 4-20 mA
- V3 : 0.5-4.5 VDC
- NV : 10-0 VDC
- NV1 : 5-0 VDC
- NA : 20-4 mA
- NV3 : 4.5-0.5 VDC

ANALOG VERSION, PROGRAMMABLE

Electrical Specifications

Measuring range	Up to 40.000 mm
Supply voltage	15...26 VDC
Current consumption	≤60 mA
Reverse polarity protection	Yes
Short circuit protection	Yes (only supply)
Response frequency	500 Hz
Resolution	0.05 mm
Linearity	±%0.5 FS
Output signal	Voltage: 0-10V, 0.5-4.5V, 0-5V (programmable) Current: 4-20 mA (programmable)
Signal characteristics	Increasing (exmp: 4-20 mA) Decreasing (exmp:20-4 mA)
Sensing device	Magnetic absolute encoder
Electrical connection	M12 connector or cable

Electrical Connection

Signal	Cable	M12 / 5 pin male connector
V+ (15...26 VDC)	Red	Pin 1
Analog output signal	Yellow	Pin 2
GND	Black	Pin 3
N/C	Green	Pin 4
SPAN/ZERO	Pink	Pin 5

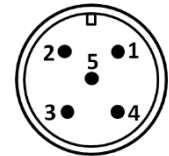

SETTING MEASUREMENT LIMITS: With this feature, you can set the minimum and maximum measurement limits.

In order to determine the **minimum measurement limit (lim1)**, the SPAN/ZERO and GND terminal are short-circuited for at least 3 seconds.

In order to determine the **maximum measurement limit (lim2)**, the SPAN/ZERO and GND terminal are short-circuited for at least 6 seconds.

To **return to the factory settings**, the SPAN/ZERO and GND terminal are short-circuited for at least 10 seconds.

SAMPLE SIGNAL OUTPUT GRAPHICS

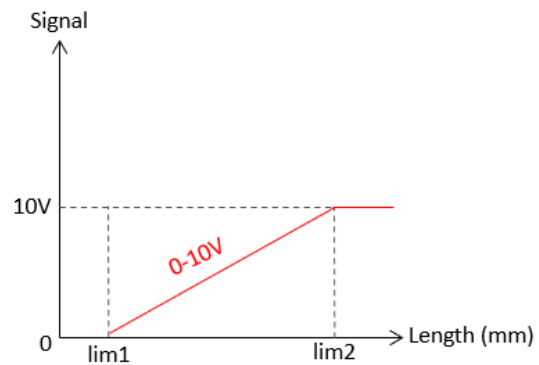
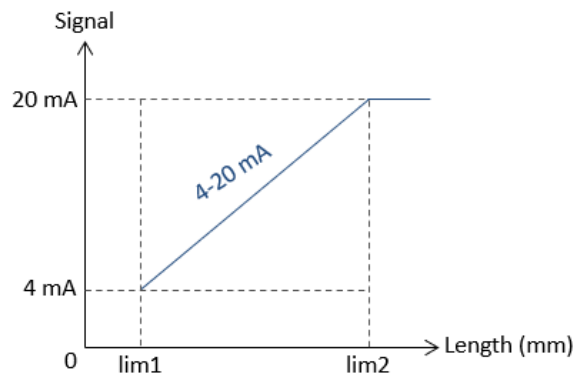

Order Code

Model	Electrical Connection	Programming Feature
AWP 740 - XXXX - XXXX - XX - XX	S13M: M12/5 pin male connector 2M: 2m cable *Optional others	PL: Programmable

Measuring Range

Up to 40.000 mm

Analog Output Signal

V : 0-10 VDC
V1 : 0-5 VDC
A : 4-20 mA
V3 : 0.5-4.5 VDC
NV : 10-0 VDC
NV1 : 5-0 VDC
NA : 20-4 mA
NV3 : 4.5-0.5 VDC

CANopen VERSION

Electrical Specifications

Measuring range	Up to 40.000 mm
Supply voltage	12...30 VDC
Current consumption	≤60 mA
Reverse polarity protection	Yes
Short circuit protection	Yes (only supply)
Response frequency	500 Hz
Resolution	50µm
Linearity	±%0.5 FS
Sensing device	Magnetic absolute encoder
Electrical connection	M12 connector or cable

CANopen Specifications

Communication Profile	CiA 301
Device Type	CANopen, CiA DS406
Node ID	Adjustable from 1 to 127 with LSS or SDO
Baud Rate	10 kBit/s, 20 kBit/s, 50 kBit/s, 100 kBit/s, 125 kBit/s, 250 kBit/s, 500 kBit/s, 800 kBit/s, 1 Mbit/s
PDO Data Rate	100 ms
Error Control	Heartbeat, Emergency Message
PDO	3 Tx PDO
PDO Modes	Event/Time triggered, Synch/Asynch
SDO	1 server
Position Information	Object Dictionary 0x6020
Termination Resistance	Optional 120Ω

Electrical Connection

Signal	Cable	M12 / 5 pin male connector
CAN SHIELD	CAN SHIELD	Pin 1
V+ (12...30VDC)	Red	Pin 2
GND	Black	Pin 3
CAN_H	Yellow	Pin 4
CAN_L	Green	Pin 5

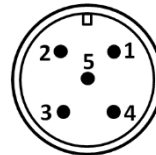

Order Code

Model		Electrical Connection				
AWP 740	-	XXXX	-	XXXX	-	X
Measuring Range			Output Signal			
Up to 40.000 mm			C : CANopen			

Electrical Connection

S13M: M12/5 pin male connector

2M: 2m cable

*Optional others

MOUNTING AND WARNINGS

1. Never release the wire after pulling. Otherwise, the coil spring will be damaged.

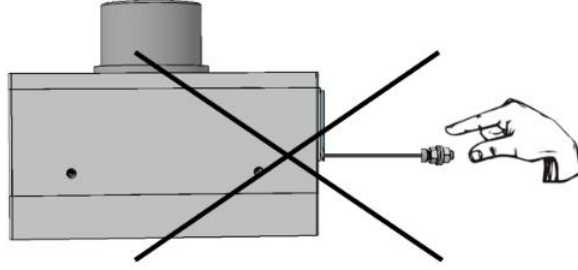

2. In order to prevent the cable from sagging over long distances, the cable carrier rollers supplied with the product should be used at regular intervals. It is recommended that the first carrier roller to be used after the sensor is used approximately 2 meters from the body, and the other carrier rollers are used every 5 meters on average.

Note: Carrier rollers will be given in the package according to the order quantity.

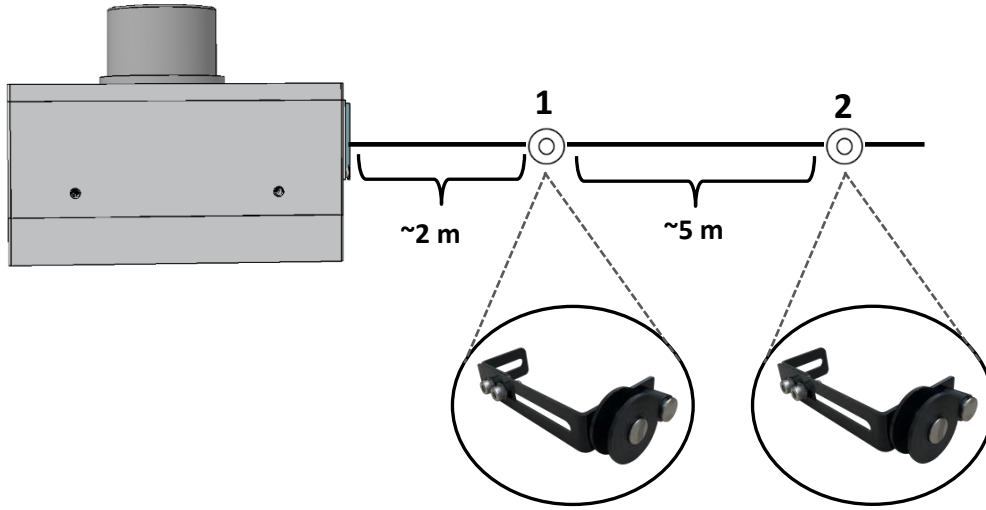

Important Note(!): Failure to comply with these recommendations, the malfunctions that may occur will not be under the warranty.